

DOCERAM
ADVANCED CERAMIC SOLUTIONS

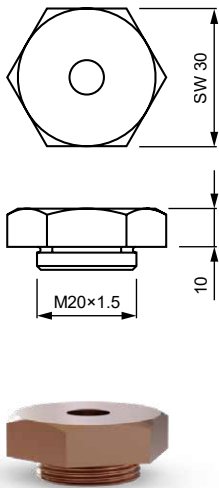

Cerazur

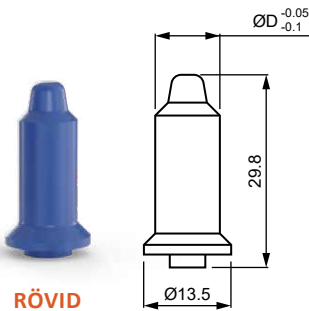

CSERÉLHETŐ ELEKTRODÁK

| LEMEZ FURAT ØD | SW 30 | LEMEZ FURAT ØD | SW 30 |
|----------------|---------------|----------------|---------------|
| 8.5 | 1111-ZK-20104 | 10.1 | 1111-ZK-20120 |
| 8.6 | 1111-ZK-20105 | 10.2 | 1111-ZK-20121 |
| 8.7 | 1111-ZK-20106 | 10.3 | 1111-ZK-20122 |
| 8.8 | 1111-ZK-20107 | 10.4 | 1111-ZK-20123 |
| 8.9 | 1111-ZK-20108 | 10.5 | 1111-ZK-20124 |
| 9.0 | 1111-ZK-20109 | 10.6 | 1111-ZK-20125 |
| 9.1 | 1111-ZK-20110 | 10.7 | 1111-ZK-20126 |
| 9.2 | 1111-ZK-20111 | 10.8 | 1111-ZK-20127 |
| 9.3 | 1111-ZK-20112 | 10.9 | 1111-ZK-20128 |
| 9.4 | 1111-ZK-20113 | 11.0 | 1111-ZK-20129 |
| 9.5 | 1111-ZK-20114 | 11.1 | 1111-ZK-20130 |
| 9.6 | 1111-ZK-20115 | 11.2 | 1111-ZK-20131 |
| 9.7 | 1111-ZK-20116 | 11.3 | 1111-ZK-20132 |
| 9.8 | 1111-ZK-20117 | 11.4 | 1111-ZK-20133 |
| 9.9 | 1111-ZK-20118 | 11.5 | 1111-ZK-20134 |
| 10.0 | 1111-ZK-20119 | | |

CERAZUR KERÁMIA TÁJOLÓCSAPOK

| LEMEZ FURAT ØD | RÖVID | HOSSZÚ | GALLÉROS |
|----------------|---------------|---------------|---------------|
| 8.5 | 8228-ZK-11053 | 8228-ZK-10053 | 8228-ZK-10353 |
| 8.6 | 8228-ZK-11054 | 8228-ZK-10054 | 8228-ZK-10354 |
| 8.7 | 8228-ZK-11055 | 8228-ZK-10055 | 8228-ZK-10355 |
| 8.8 | 8228-ZK-11056 | 8228-ZK-10056 | 8228-ZK-10356 |
| 8.9 | 8228-ZK-11057 | 8228-ZK-10057 | 8228-ZK-10357 |
| 9.0 | 8228-ZK-11058 | 8228-ZK-10058 | 8228-ZK-10358 |
| 9.1 | 8228-ZK-11059 | 8228-ZK-10059 | 8228-ZK-10359 |
| 9.2 | 8228-ZK-11060 | 8228-ZK-10060 | 8228-ZK-10360 |
| 9.3 | 8228-ZK-11061 | 8228-ZK-10061 | 8228-ZK-10361 |
| 9.4 | 8228-ZK-11062 | 8228-ZK-10062 | 8228-ZK-10362 |
| 9.5 | 8228-ZK-11063 | 8228-ZK-10063 | 8228-ZK-10363 |
| 9.6 | 8228-ZK-11064 | 8228-ZK-10064 | 8228-ZK-10364 |
| 9.7 | 8228-ZK-11065 | 8228-ZK-10065 | 8228-ZK-10365 |
| 9.8 | 8228-ZK-11066 | 8228-ZK-10066 | 8228-ZK-10366 |
| 9.9 | 8228-ZK-11067 | 8228-ZK-10067 | 8228-ZK-10367 |
| 10.0 | 8228-ZK-11068 | 8228-ZK-10068 | 8228-ZK-10368 |
| 10.1 | 8228-ZK-11069 | 8228-ZK-10069 | 8228-ZK-10369 |
| 10.2 | 8228-ZK-11070 | 8228-ZK-10070 | 8228-ZK-10370 |
| 10.3 | 8228-ZK-11071 | 8228-ZK-10071 | 8228-ZK-10371 |
| 10.4 | 8228-ZK-11072 | 8228-ZK-10072 | 8228-ZK-10372 |
| 10.5 | 8228-ZK-11073 | 8228-ZK-10073 | 8228-ZK-10373 |
| 10.6 | 8228-ZK-11074 | 8228-ZK-10074 | 8228-ZK-10374 |
| 10.7 | 8228-ZK-11075 | 8228-ZK-10075 | 8228-ZK-10375 |
| 10.8 | 8228-ZK-11076 | 8228-ZK-10076 | 8228-ZK-10376 |
| 10.9 | 8228-ZK-11077 | 8228-ZK-10077 | 8228-ZK-10377 |
| 11.0 | 8228-ZK-11078 | 8228-ZK-10078 | 8228-ZK-10378 |



Megrendelésre Volcera anyagból készült tájolócsapokat is szállítunk.
Termékkód: „8440-ZK-xxxx” (az „xxxx” a táblázatban lévő utolsó öt szám)

ELEKTRODATARTÓK

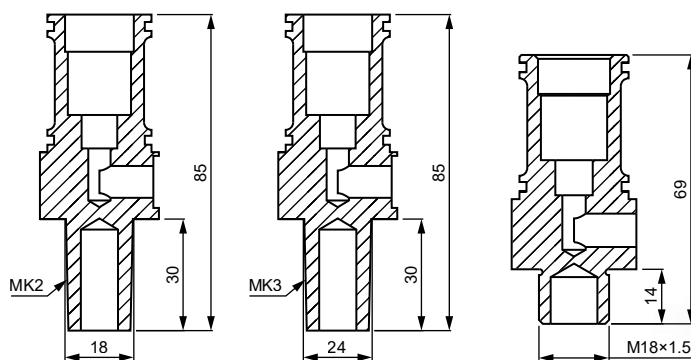

| ANYA MÉRET | MK2 KÚP | MK3 KÚP | M18x1.5 MENET |
|------------|---------------|---------------|---------------|
| M8 | 1111-ZK-20542 | 1111-ZK-20543 | 1111-ZK-20562 |

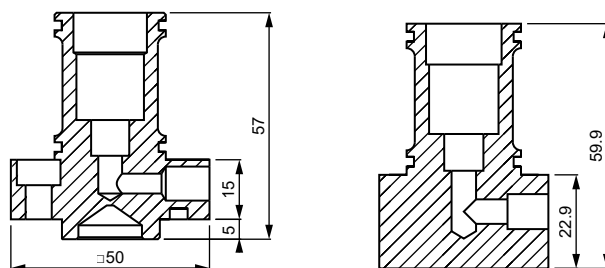

| ANYA MÉRET | R-TÍPUS | C-TÍPUS |
|------------|---------------|---------------|
| M8 | 1111-ZK-20642 | 1111-ZK-20662 |

HŰTŐ GYŰRŰ

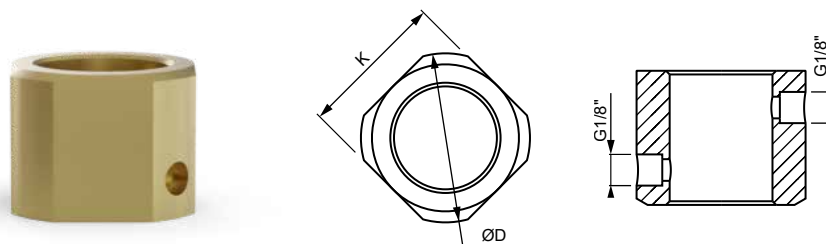

| ANYA MÉRET | MEGJELÖLÉS | ØD | K |
|-----------------|---------------|----|----|
| M4 – M8 | 1113-ZK-19766 | 46 | 40 |
| C-típus M4 – M8 | 1113-ZK-19766 | 46 | 40 |

TARTOZÉKOK ELEKTRODATARTÓKHOZ

RUGÓ



O-GYŰRŰ



GYORSCSATLAKOZÓ

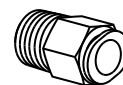

| TARTÓ HOSSZ | MEGJELÖLÉS |
|-------------|---------------|
| 40 mm-tól | 1112-ZK-12206 |

| TARTÓ TÍPUS | MEGJELÖLÉS |
|-------------|---------------|
| Ø28 | 1123-ZK-16436 |

| — | MEGJELÖLÉS |
|-----------------------------------|---------------|
| sűrített levegő bevezető G1/8"-Ø6 | 1116-ZK-12353 |

DOCCERAM
ADVANCED CERAMIC SOLUTIONS

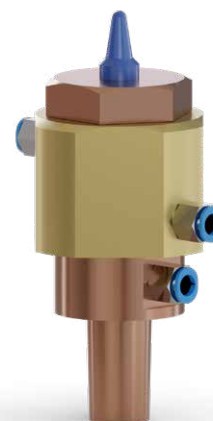

CSERÉLHETŐ
ELEKTRODA



HŰTŐ
GYŰRŰ



TÁJOLÓCSAP



RUGÓ



ELEKTRODA
TARTÓ
O-GYŰRŰKKEL



GYORSCSATLAKOZÓ
SŰRÍTETT
LEVEGŐRE

