

DOCERAM  
ADVANCED CERAMIC SOLUTIONS

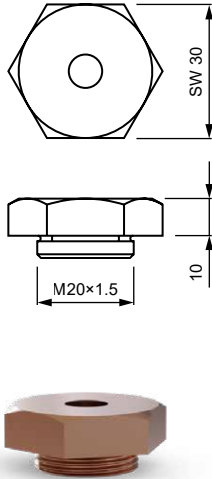

Cerazur

CSERÉLHETŐ ELEKTRODÁK

LEMEZ FURAT ØD	SW 30	LEMEZ FURAT ØD	SW 30
6.5	1111-ZK-20031	7.8	1111-ZK-20044
6.6	1111-ZK-20032	7.9	1111-ZK-20045
6.7	1111-ZK-20033	8.0	1111-ZK-20046
6.8	1111-ZK-20034	8.1	1111-ZK-20047
6.9	1111-ZK-20035	8.2	1111-ZK-20048
7.0	1111-ZK-20036	8.3	1111-ZK-20049
7.1	1111-ZK-20037	8.4	1111-ZK-20050
7.2	1111-ZK-20038	8.5	1111-ZK-20051
7.3	1111-ZK-20039	8.6	1111-ZK-20052
7.4	1111-ZK-20040	8.7	1111-ZK-20053
7.5	1111-ZK-20041	8.8	1111-ZK-20054
7.6	1111-ZK-20042	8.9	1111-ZK-20055
7.7	1111-ZK-20043	9.0	1111-ZK-20056



RÖVID

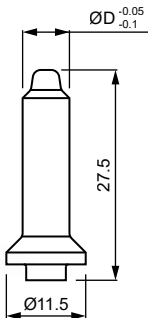

HOSSZÚ

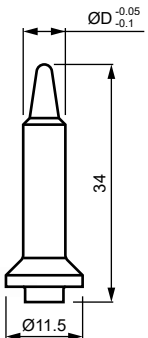

GALLÉROS

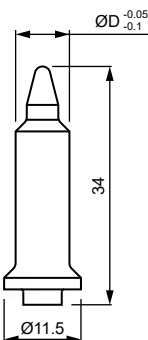

CERAZUR KERÁMIA TÁJOLÓCSAPOK

LEMEZ FURAT ØD	RÖVID	HOSSZÚ	GALLÉROS
6.5	8228-ZK-11032	8228-ZK-10032	8228-ZK-10332
6.6	8228-ZK-11033	8228-ZK-10033	8228-ZK-10333
6.7	8228-ZK-11034	8228-ZK-10034	8228-ZK-10334
6.8	8228-ZK-11035	8228-ZK-10035	8228-ZK-10335
6.9	8228-ZK-11036	8228-ZK-10036	8228-ZK-10336
7.0	8228-ZK-11037	8228-ZK-10037	8228-ZK-10337
7.1	8228-ZK-11038	8228-ZK-10038	8228-ZK-10338
7.2	8228-ZK-11039	8228-ZK-10039	8228-ZK-10339
7.3	8228-ZK-11040	8228-ZK-10040	8228-ZK-10340
7.4	8228-ZK-11041	8228-ZK-10041	8228-ZK-10341
7.5	8228-ZK-11042	8228-ZK-10042	8228-ZK-10342
7.6	8228-ZK-11043	8228-ZK-10043	8228-ZK-10343
7.7	8228-ZK-11044	8228-ZK-10044	8228-ZK-10344
7.8	8228-ZK-11045	8228-ZK-10045	8228-ZK-10345
7.9	8228-ZK-11046	8228-ZK-10046	8228-ZK-10346
8.0	8228-ZK-11047	8228-ZK-10047	8228-ZK-10347
8.1	8228-ZK-11048	8228-ZK-10048	8228-ZK-10348
8.2	8228-ZK-11049	8228-ZK-10049	8228-ZK-10349
8.3	8228-ZK-11050	8228-ZK-10050	8228-ZK-10350
8.4	8228-ZK-11051	8228-ZK-10051	8228-ZK-10351
8.5	8228-ZK-11052	8228-ZK-10052	8228-ZK-10352



Megrendelésre Volcera anyagból készült tájolócsapokat is szállítunk.  
Termékkód: „8440-ZK-xxxx” (az „xxxx” a táblázatban szereplő  
termékek utolsó öt számával azonos, pl. Ø6.5-nél a kód 8440-ZK-11032)

### ELEKTRODATARTÓK

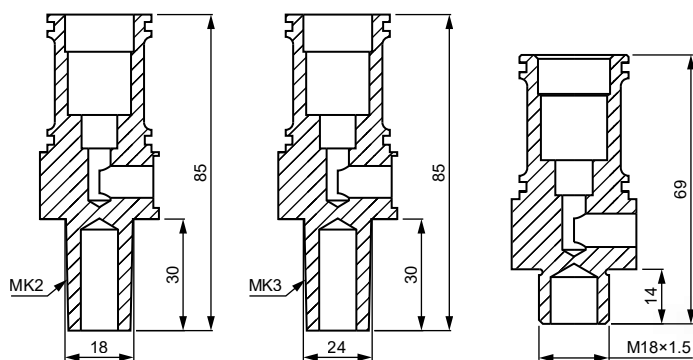

ANYA MÉRET	MK2 KÚP	MK3 KÚP	M18x1.5 MENET
M6	1111-ZK-20542	1111-ZK-20543	1111-ZK-20562

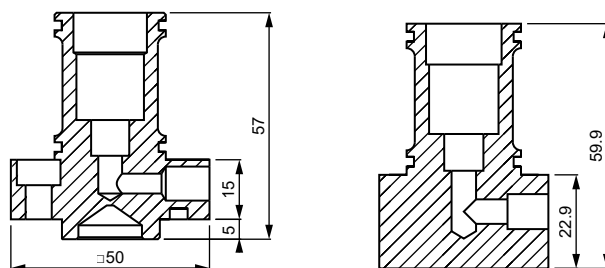

ANYA MÉRET	R-TÍPUS	C-TÍPUS
M6	1111-ZK-20642	1111-ZK-20662

### HŰTŐ GYŰRŰ

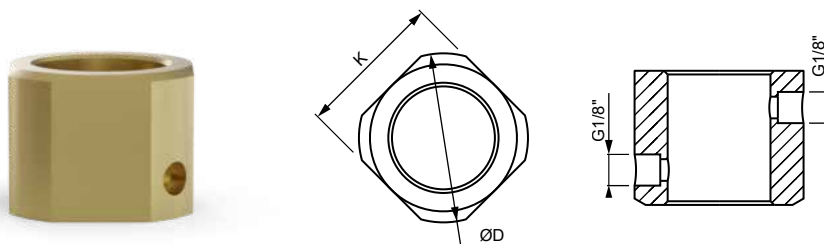

ANYA MÉRET	MEGJELÖLÉS	ØD	K
M4 – M8	1113-ZK-19766	46	40
C-típus M4 – M8	1113-ZK-19766	46	40

### TARTOZÉKOK ELEKTRODATARTÓKHOZ

RUGÓ



TARTÓ HOSSZ	MEGJELÖLÉS
40 mm-tól	1112-ZK-12206

O-GYŰRŰ



TARTÓ TÍPUS	MEGJELÖLÉS
Ø28	1123-ZK-16436

GYORSCSATLAKOZÓ



—	MEGJELÖLÉS
sűrített levegő bevezető G1/8"-Ø6	1116-ZK-12353

DOCCERAM  
ADVANCED CERAMIC SOLUTIONS

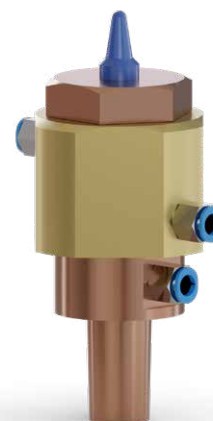

CSERÉLHETŐ  
ELEKTRODA



HŰTŐ  
GYŰRŰ



TÁJOLÓCSAP



RUGÓ



ELEKTRODA  
TARTÓ  
O-GYŰRŰKKEL



GYORS-  
CSATLAKOZÓ  
SŰRÍTETT  
LEVEGŐRE

