

DOCERAM
ADVANCED CERAMIC SOLUTIONS

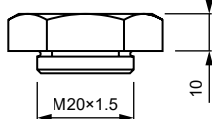

Cerazur

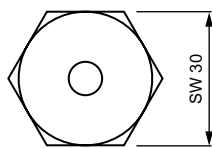

RÖVID

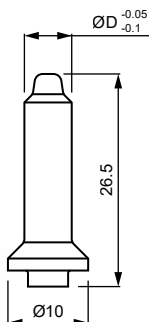

HOSSZÚ

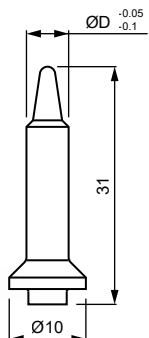

GALLÉROS

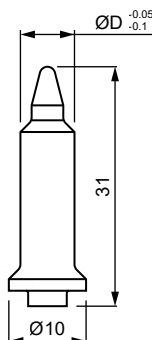

CSERÉLHETŐ ELEKTÓDÁK

LEMEZ FURAT ØD	SW 30
5.5	1111-ZK-20010
5.6	1111-ZK-20011
5.7	1111-ZK-20012
5.8	1111-ZK-20013
5.9	1111-ZK-20014
6.0	1111-ZK-20015
6.1	1111-ZK-20016
6.2	1111-ZK-20017
6.3	1111-ZK-20018
6.4	1111-ZK-20019
6.5	1111-ZK-20020
6.6	1111-ZK-20021
6.7	1111-ZK-20022
6.8	1111-ZK-20023
6.9	1111-ZK-20024
7.0	1111-ZK-20025
7.1	1111-ZK-20026
7.2	1111-ZK-20027
7.3	1111-ZK-20028
7.4	1111-ZK-20029
7.5	1111-ZK-20030

CERAZUR KERÁMIA TÁJOLÓCSAPOK

LEMEZ FURAT ØD	RÖVID	HOSSZÚ	GALLÉROS
5.5	8228-ZK-11016	8228-ZK-10016	8228-ZK-10316
5.6	8228-ZK-11017	8228-ZK-10017	8228-ZK-10317
5.7	8228-ZK-11018	8228-ZK-10018	8228-ZK-10318
5.8	8228-ZK-11019	8228-ZK-10019	8228-ZK-10319
5.9	8228-ZK-11020	8228-ZK-10020	8228-ZK-10320
6.0	8228-ZK-11021	8228-ZK-10021	8228-ZK-10321
6.1	8228-ZK-11022	8228-ZK-10022	8228-ZK-10322
6.2	8228-ZK-11023	8228-ZK-10023	8228-ZK-10323
6.3	8228-ZK-11024	8228-ZK-10024	8228-ZK-10324
6.4	8228-ZK-11025	8228-ZK-10025	8228-ZK-10325
6.5	8228-ZK-11026	8228-ZK-10026	8228-ZK-10326
6.6	8228-ZK-11027	8228-ZK-10027	8228-ZK-10327
6.7	8228-ZK-11028	8228-ZK-10028	8228-ZK-10328
6.8	8228-ZK-11029	8228-ZK-10029	8228-ZK-10329
6.9	8228-ZK-11030	8228-ZK-10030	8228-ZK-10330
7.0	8228-ZK-11031	8228-ZK-10031	8228-ZK-10331



Megrendelésre Volcera anyagból készült tájolócsapokat is szállítunk.
Termékkód: „8440-ZK-xxxx” (az „xxxx” a táblázatban szereplő
termékek utolsó öt számával azonos, pl. Ø5.5-nél a kód 8440-ZK-11016)

ELEKTRODATARTÓK

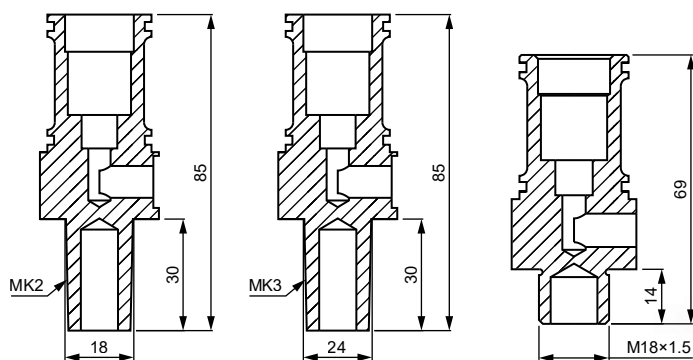

ANYA MÉRET	MK2 KÚP	MK3 KÚP	M18x1.5 MENET
M5	1111-ZK-20542	1111-ZK-20543	1111-ZK-20562

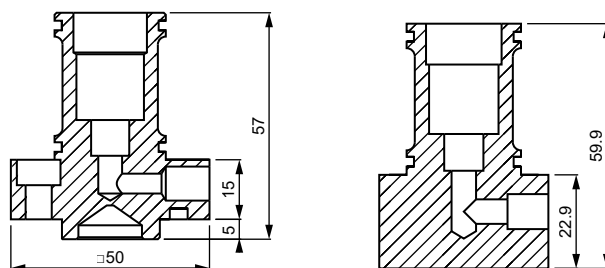

ANYA MÉRET	R-TÍPUS	C-TÍPUS
M5	1111-ZK-20642	1111-ZK-20662

HŰTŐ GYŰRŰ

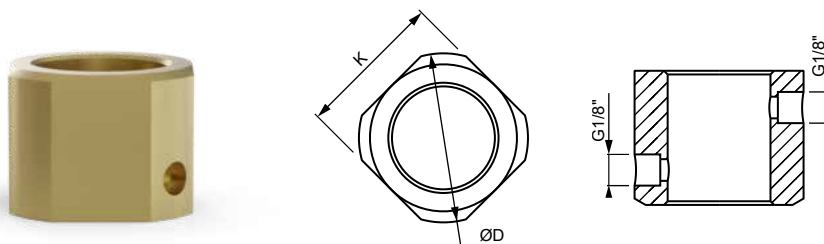

ANYA MÉRET	MEGJELÖLÉS	$\varnothing D$	K
M4 – M8	1113-ZK-19766	46	40
C-típus M4 – M8	1113-ZK-19766	46	40

TARTOZÉKOK ELEKTRODATARTÓKHOZ

RUGÓ



O-GYŰRŰ



GYORSCSATLAKOZÓ



TARTÓ HOSSZ	MEGJELÖLÉS
30 mm-ig	1112-ZK-12205
40 mm-tól	1112-ZK-12204

TARTÓ TÍPUS	MEGJELÖLÉS
$\varnothing 28$	1123-ZK-16436

—	MEGJELÖLÉS
sűrített levegő bevezető $G1/8''-\varnothing 6$	1116-ZK-12353

DOCCERAM
ADVANCED CERAMIC SOLUTIONS

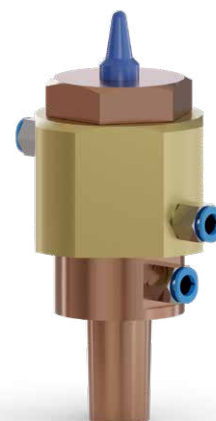

CSERÉLHETŐ
ELEKTRODA



HŰTŐ
GYŰRŰ



TÁJOLÓCSAP



RUGÓ



ELEKTRODA
TARTÓ
O-GYŰRŰKKEL



GYORS-
CSATLAKOZÓ
SŰRÍTETT
LEVEGŐRE

