

RÖVID

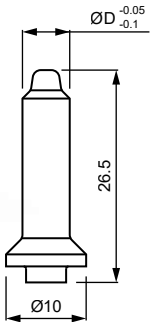

HOSSZÚ

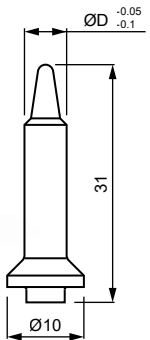

GALLÉROS

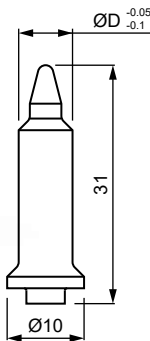

CSERÉLHETŐ ELEKTÓDÁK

LEMEZ FURAT ØD	SW 30
4.5	1111-ZK-20000
4.6	1111-ZK-20001
4.7	1111-ZK-20002
4.8	1111-ZK-20003
4.9	1111-ZK-20004
5.0	1111-ZK-20005
5.1	1111-ZK-20006
5.2	1111-ZK-20007
5.3	1111-ZK-20008
5.4	1111-ZK-20009
5.5	1111-ZK-20010
5.6	1111-ZK-20011
5.7	1111-ZK-20012
5.8	1111-ZK-20013
5.9	1111-ZK-20014
6.0	1111-ZK-20015
6.1	1111-ZK-20016
6.2	1111-ZK-20017
6.3	1111-ZK-20018
6.4	1111-ZK-20019
6.5	1111-ZK-20020

CERAZUR KERÁMIA TÁJOLÓCSAPOK

LEMEZ FURAT ØD	RÖVID	HOSSZÚ	GALLÉROS
4.5	8228-ZK-11000	8228-ZK-10000	8228-ZK-10300
4.6	8228-ZK-11001	8228-ZK-10001	8228-ZK-10301
4.7	8228-ZK-11002	8228-ZK-10002	8228-ZK-10302
4.8	8228-ZK-11003	8228-ZK-10003	8228-ZK-10303
4.9	8228-ZK-11004	8228-ZK-10004	8228-ZK-10304
5.0	8228-ZK-11005	8228-ZK-10005	8228-ZK-10305
5.1	8228-ZK-11006	8228-ZK-10006	8228-ZK-10306
5.2	8228-ZK-11007	8228-ZK-10007	8228-ZK-10307
5.3	8228-ZK-11008	8228-ZK-10008	8228-ZK-10308
5.4	8228-ZK-11009	8228-ZK-10009	8228-ZK-10309
5.5	8228-ZK-11010	8228-ZK-10010	8228-ZK-10310
5.6	8228-ZK-11011	8228-ZK-10011	8228-ZK-10311
5.7	8228-ZK-11012	8228-ZK-10012	8228-ZK-10312
5.8	8228-ZK-11013	8228-ZK-10013	8228-ZK-10313
5.9	8228-ZK-11014	8228-ZK-10014	8228-ZK-10314
6.0	8228-ZK-11015	8228-ZK-10015	8228-ZK-10315



Megrendelésre Volcera anyagból készült tájolócsapokat is szállítunk.
Termékkód: „8440-ZK-xxxx” (az „xxxx” a táblázatban szereplő
termékek utolsó öt számával azonos, pl. Ø4.5-nél a kód 8440-ZK-11000)

M4 CSAVARANYA HEGESZTŐ ÖSSZEÁLLÍTÁS

VÍZHŰTÉSŰ

Pro
Spot

ELEKTRODATARTÓK

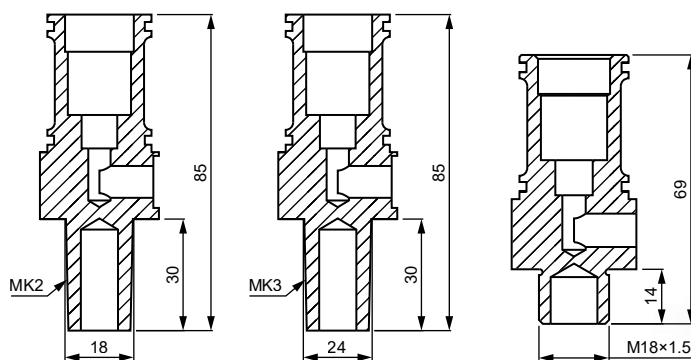

ANYA MÉRET	MK2 KÚP	MK3 KÚP	M18x1.5 MENET
M4	1111-ZK-20542	1111-ZK-20543	1111-ZK-20562

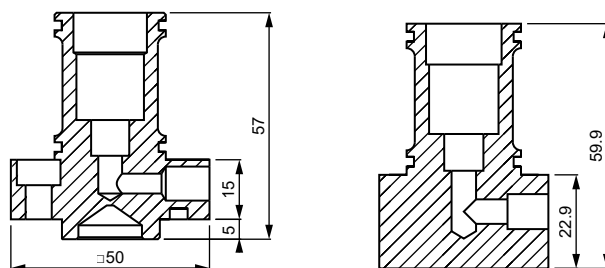

ANYA MÉRET	R-TÍPUS	C-TÍPUS
M4	1111-ZK-20642	1111-ZK-20662

HŰTŐ GYŰRŰ

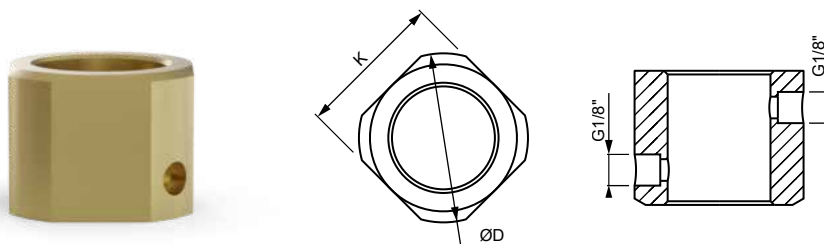

ANYA MÉRET	MEGJELÖLÉS	$\varnothing D$	K
M4 – M8	1113-ZK-19766	46	40
C-típus M4 – M8	1113-ZK-19766	46	40

TARTOZÉKOK ELEKTRODATARTÓKHOZ

RUGÓ



O-GYŰRŰ



GYORSCSATLAKOZÓ



TARTÓ HOSSZ	MEGJELÖLÉS
30 mm-ig	1112-ZK-12205
40 mm-tól	1112-ZK-12204

TARTÓ TÍPUS	MEGJELÖLÉS
$\varnothing 28$	1123-ZK-16436

—	MEGJELÖLÉS
sűrített levegő bevezető G1/8"- $\varnothing 6$	1116-ZK-12353

ADVANCED CERAMIC SOLUTIONS
DOCERAM[®]

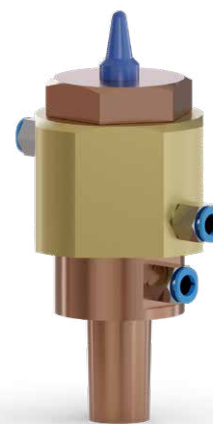

CSERÉLHETŐ
ELEKTRODA



HŰTŐ
GYŰRŰ



TÁJOLÓCSAP



RUGÓ



ELEKTRODA
TARTÓ
O-GYŰRŰKKEL



GYORS-
CSATLAKOZÓ
SŰRÍTETT
LEVEGŐRE



®
DOCERAM
ADVANCED CERAMIC SOLUTIONS

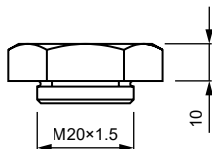
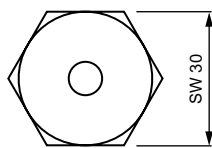

Cerazur



RÖVID

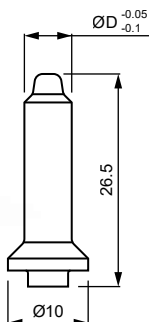

HOSSZÚ

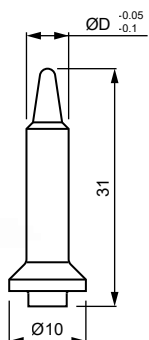

GALLÉROS

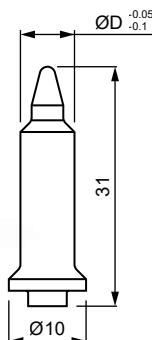

CSERÉLHETŐ ELEKTÓDÁK

LEMEZ FURAT ØD	SW 30
5.5	1111-ZK-20010
5.6	1111-ZK-20011
5.7	1111-ZK-20012
5.8	1111-ZK-20013
5.9	1111-ZK-20014
6.0	1111-ZK-20015
6.1	1111-ZK-20016
6.2	1111-ZK-20017
6.3	1111-ZK-20018
6.4	1111-ZK-20019
6.5	1111-ZK-20020
6.6	1111-ZK-20021
6.7	1111-ZK-20022
6.8	1111-ZK-20023
6.9	1111-ZK-20024
7.0	1111-ZK-20025
7.1	1111-ZK-20026
7.2	1111-ZK-20027
7.3	1111-ZK-20028
7.4	1111-ZK-20029
7.5	1111-ZK-20030

CERAZUR KERÁMIA TÁJOLÓCSAPOK

LEMEZ FURAT ØD	RÖVID	HOSSZÚ	GALLÉROS
5.5	8228-ZK-11016	8228-ZK-10016	8228-ZK-10316
5.6	8228-ZK-11017	8228-ZK-10017	8228-ZK-10317
5.7	8228-ZK-11018	8228-ZK-10018	8228-ZK-10318
5.8	8228-ZK-11019	8228-ZK-10019	8228-ZK-10319
5.9	8228-ZK-11020	8228-ZK-10020	8228-ZK-10320
6.0	8228-ZK-11021	8228-ZK-10021	8228-ZK-10321
6.1	8228-ZK-11022	8228-ZK-10022	8228-ZK-10322
6.2	8228-ZK-11023	8228-ZK-10023	8228-ZK-10323
6.3	8228-ZK-11024	8228-ZK-10024	8228-ZK-10324
6.4	8228-ZK-11025	8228-ZK-10025	8228-ZK-10325
6.5	8228-ZK-11026	8228-ZK-10026	8228-ZK-10326
6.6	8228-ZK-11027	8228-ZK-10027	8228-ZK-10327
6.7	8228-ZK-11028	8228-ZK-10028	8228-ZK-10328
6.8	8228-ZK-11029	8228-ZK-10029	8228-ZK-10329
6.9	8228-ZK-11030	8228-ZK-10030	8228-ZK-10330
7.0	8228-ZK-11031	8228-ZK-10031	8228-ZK-10331



Megrendelésre Volcera anyagból készült tájolócsapokat is szállítunk.
Termékkód: „8440-ZK-xxxx” (az „xxxx” a táblázatban szereplő
termékek utolsó öt számával azonos, pl. Ø5.5-nél a kód 8440-ZK-11016)

M5 CSAVARANYA HEGESZTŐ ÖSSZEÁLLÍTÁS VÍZHŰTÉSŰ

Pro
Spot

ELEKTRODATARTÓK

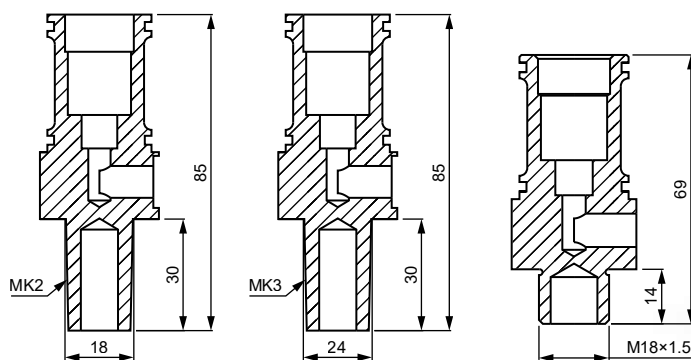

ANYA MÉRET	MK2 KÚP	MK3 KÚP	M18x1.5 MENET
M5	1111-ZK-20542	1111-ZK-20543	1111-ZK-20562

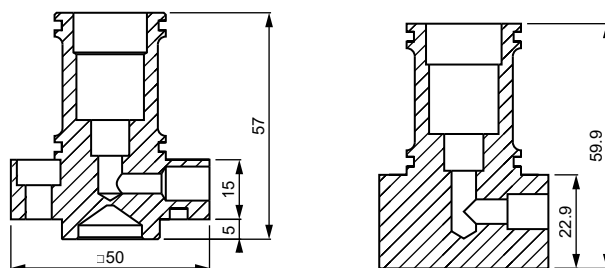

ANYA MÉRET	R-TÍPUS	C-TÍPUS
M5	1111-ZK-20642	1111-ZK-20662

HŰTŐ GYŰRŰ

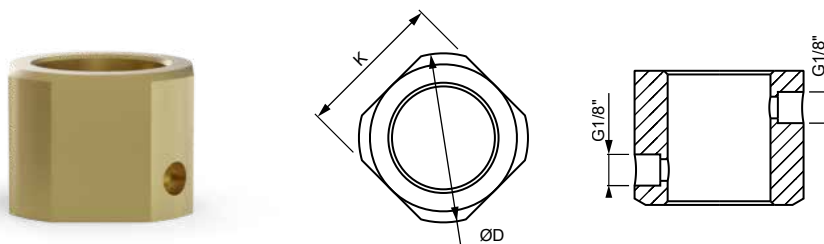

ANYA MÉRET	MEGJELÖLÉS	ØD	K
M4 – M8	1113-ZK-19766	46	40
C-típus M4 – M8	1113-ZK-19766	46	40

TARTOZÉKOK ELEKTRODATARTÓKHOZ

RUGÓ

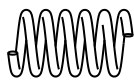

TARTÓ HOSSZ	MEGJELÖLÉS
30 mm-ig	1112-ZK-12205
40 mm-tól	1112-ZK-12204

O-GYŰRŰ



TARTÓ TÍPUS	MEGJELÖLÉS
Ø28	1123-ZK-16436

GYORSCSATLAKOZÓ



—	MEGJELÖLÉS
sűrített levegő bevezető G1/8"-Ø6	1116-ZK-12353

DOCCERAM
ADVANCED CERAMIC SOLUTIONS

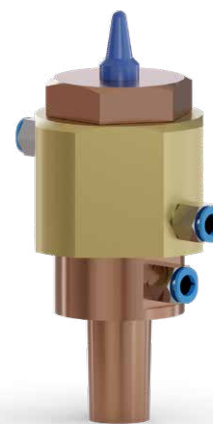

CSERÉLHETŐ
ELEKTRODA



HŰTŐ
GYŰRŰ

TÁJOLÓCSAP



RUGÓ



ELEKTRODA
TARTÓ
O-GYŰRŰKKEL



GYORS-
CSATLAKOZÓ
SŰRÍTETT
LEVEGŐRE



DOCERAM
ADVANCED CERAMIC SOLUTIONS

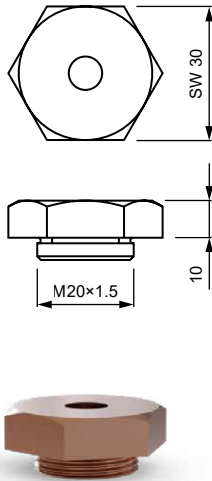

Cerazur



RÖVID

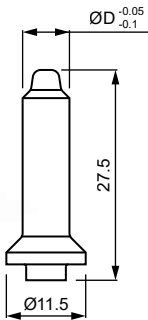

HOSSZÚ

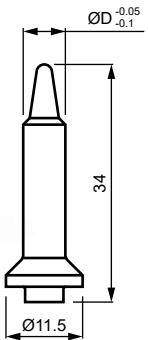

GALLÉROS

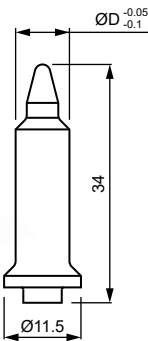

CSERÉLHETŐ ELEKTRODÁK

LEMEZ FURAT ØD	SW 30	LEMEZ FURAT ØD	SW 30
6.5	1111-ZK-20031	7.8	1111-ZK-20044
6.6	1111-ZK-20032	7.9	1111-ZK-20045
6.7	1111-ZK-20033	8.0	1111-ZK-20046
6.8	1111-ZK-20034	8.1	1111-ZK-20047
6.9	1111-ZK-20035	8.2	1111-ZK-20048
7.0	1111-ZK-20036	8.3	1111-ZK-20049
7.1	1111-ZK-20037	8.4	1111-ZK-20050
7.2	1111-ZK-20038	8.5	1111-ZK-20051
7.3	1111-ZK-20039	8.6	1111-ZK-20052
7.4	1111-ZK-20040	8.7	1111-ZK-20053
7.5	1111-ZK-20041	8.8	1111-ZK-20054
7.6	1111-ZK-20042	8.9	1111-ZK-20055
7.7	1111-ZK-20043	9.0	1111-ZK-20056

CERAZUR KERÁMIA TÁJOLÓCSAPOK

LEMEZ FURAT ØD	RÖVID	HOSSZÚ	GALLÉROS
6.5	8228-ZK-11032	8228-ZK-10032	8228-ZK-10332
6.6	8228-ZK-11033	8228-ZK-10033	8228-ZK-10333
6.7	8228-ZK-11034	8228-ZK-10034	8228-ZK-10334
6.8	8228-ZK-11035	8228-ZK-10035	8228-ZK-10335
6.9	8228-ZK-11036	8228-ZK-10036	8228-ZK-10336
7.0	8228-ZK-11037	8228-ZK-10037	8228-ZK-10337
7.1	8228-ZK-11038	8228-ZK-10038	8228-ZK-10338
7.2	8228-ZK-11039	8228-ZK-10039	8228-ZK-10339
7.3	8228-ZK-11040	8228-ZK-10040	8228-ZK-10340
7.4	8228-ZK-11041	8228-ZK-10041	8228-ZK-10341
7.5	8228-ZK-11042	8228-ZK-10042	8228-ZK-10342
7.6	8228-ZK-11043	8228-ZK-10043	8228-ZK-10343
7.7	8228-ZK-11044	8228-ZK-10044	8228-ZK-10344
7.8	8228-ZK-11045	8228-ZK-10045	8228-ZK-10345
7.9	8228-ZK-11046	8228-ZK-10046	8228-ZK-10346
8.0	8228-ZK-11047	8228-ZK-10047	8228-ZK-10347
8.1	8228-ZK-11048	8228-ZK-10048	8228-ZK-10348
8.2	8228-ZK-11049	8228-ZK-10049	8228-ZK-10349
8.3	8228-ZK-11050	8228-ZK-10050	8228-ZK-10350
8.4	8228-ZK-11051	8228-ZK-10051	8228-ZK-10351
8.5	8228-ZK-11052	8228-ZK-10052	8228-ZK-10352



Megrendelésre Volcera anyagból készült tájolócsapokat is szállítunk.
Termékkód: „8440-ZK-xxxx” (az „xxxx” a táblázatban szereplő
termékek utolsó öt számával azonos, pl. Ø6.5-nél a kód 8440-ZK-11032)

ELEKTRODATARTÓK

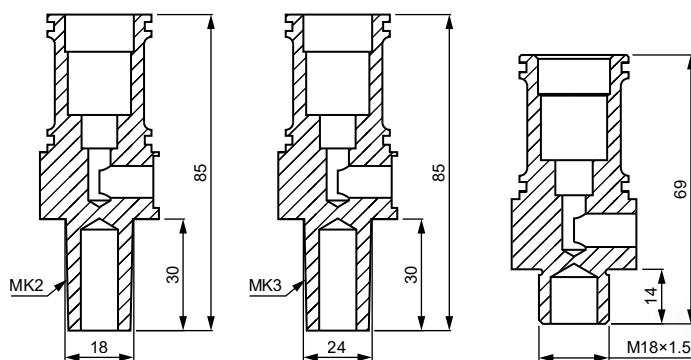

ANYA MÉRET	MK2 KÚP	MK3 KÚP	M18x1.5 MENET
M6	1111-ZK-20542	1111-ZK-20543	1111-ZK-20562

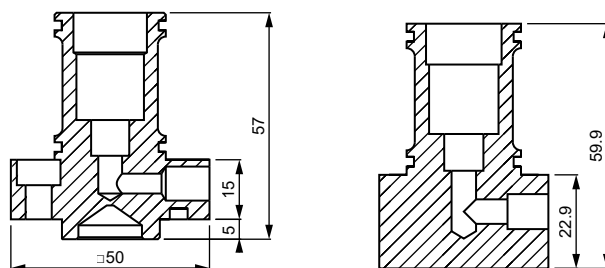

ANYA MÉRET	R-TÍPUS	C-TÍPUS
M6	1111-ZK-20642	1111-ZK-20662

HŰTŐ GYŰRŰ

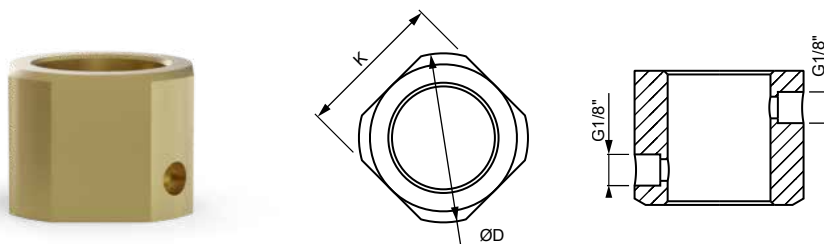

ANYA MÉRET	MEGJELÖLÉS	$\varnothing D$	K
M4 – M8	1113-ZK-19766	46	40
C-típus M4 – M8	1113-ZK-19766	46	40

TARTOZÉKOK ELEKTRODATARTÓKHOZ

RUGÓ



TARTÓ HOSSZ	MEGJELÖLÉS
40 mm-tól	1112-ZK-12206

O-GYŰRŰ



TARTÓ TÍPUS	MEGJELÖLÉS
$\varnothing 28$	1123-ZK-16436

GYORSCSATLAKOZÓ



—	MEGJELÖLÉS
sűrített levegő bevezető G1/8"- $\varnothing 6$	1116-ZK-12353

DOCCERAM
ADVANCED CERAMIC SOLUTIONS

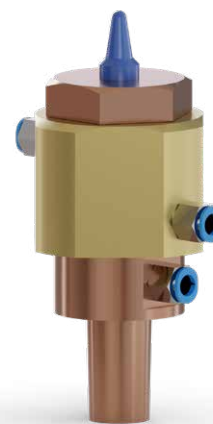

CSERÉLHETŐ
ELEKTRODA



HŰTŐ
GYŰRŰ



TÁJOLÓCSAP



RUGÓ



ELEKTRODA
TARTÓ
O-GYŰRŰKKEL



GYORS-
CSATLAKOZÓ
SŰRÍTETT
LEVEGŐRE



DOCERAM
ADVANCED CERAMIC SOLUTIONS

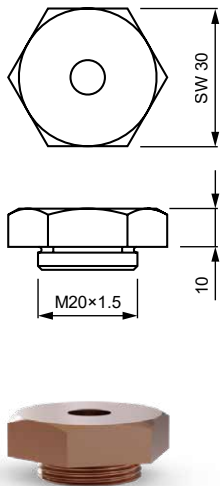

Cerazur



RÖVID

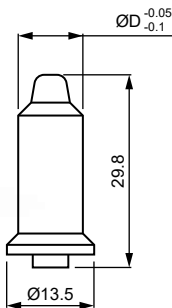

HOSSZÚ

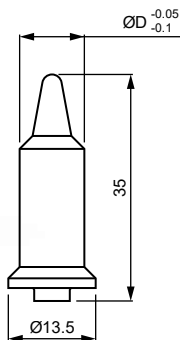

GALLÉROS

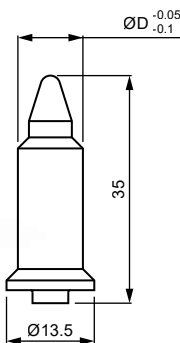

CSERÉLHETŐ ELEKTÓDÁK

LEMEZ FURAT ØD	SW 30	LEMEZ FURAT ØD	SW 30
8.5	1111-ZK-20104	10.1	1111-ZK-20120
8.6	1111-ZK-20105	10.2	1111-ZK-20121
8.7	1111-ZK-20106	10.3	1111-ZK-20122
8.8	1111-ZK-20107	10.4	1111-ZK-20123
8.9	1111-ZK-20108	10.5	1111-ZK-20124
9.0	1111-ZK-20109	10.6	1111-ZK-20125
9.1	1111-ZK-20110	10.7	1111-ZK-20126
9.2	1111-ZK-20111	10.8	1111-ZK-20127
9.3	1111-ZK-20112	10.9	1111-ZK-20128
9.4	1111-ZK-20113	11.0	1111-ZK-20129
9.5	1111-ZK-20114	11.1	1111-ZK-20130
9.6	1111-ZK-20115	11.2	1111-ZK-20131
9.7	1111-ZK-20116	11.3	1111-ZK-20132
9.8	1111-ZK-20117	11.4	1111-ZK-20133
9.9	1111-ZK-20118	11.5	1111-ZK-20134
10.0	1111-ZK-20119		

CERAZUR KERÁMIA TÁJOLÓCSAPOK

LEMEZ FURAT ØD	RÖVID	HOSSZÚ	GALLÉROS
8.5	8228-ZK-11053	8228-ZK-10053	8228-ZK-10353
8.6	8228-ZK-11054	8228-ZK-10054	8228-ZK-10354
8.7	8228-ZK-11055	8228-ZK-10055	8228-ZK-10355
8.8	8228-ZK-11056	8228-ZK-10056	8228-ZK-10356
8.9	8228-ZK-11057	8228-ZK-10057	8228-ZK-10357
9.0	8228-ZK-11058	8228-ZK-10058	8228-ZK-10358
9.1	8228-ZK-11059	8228-ZK-10059	8228-ZK-10359
9.2	8228-ZK-11060	8228-ZK-10060	8228-ZK-10360
9.3	8228-ZK-11061	8228-ZK-10061	8228-ZK-10361
9.4	8228-ZK-11062	8228-ZK-10062	8228-ZK-10362
9.5	8228-ZK-11063	8228-ZK-10063	8228-ZK-10363
9.6	8228-ZK-11064	8228-ZK-10064	8228-ZK-10364
9.7	8228-ZK-11065	8228-ZK-10065	8228-ZK-10365
9.8	8228-ZK-11066	8228-ZK-10066	8228-ZK-10366
9.9	8228-ZK-11067	8228-ZK-10067	8228-ZK-10367
10.0	8228-ZK-11068	8228-ZK-10068	8228-ZK-10368
10.1	8228-ZK-11069	8228-ZK-10069	8228-ZK-10369
10.2	8228-ZK-11070	8228-ZK-10070	8228-ZK-10370
10.3	8228-ZK-11071	8228-ZK-10071	8228-ZK-10371
10.4	8228-ZK-11072	8228-ZK-10072	8228-ZK-10372
10.5	8228-ZK-11073	8228-ZK-10073	8228-ZK-10373
10.6	8228-ZK-11074	8228-ZK-10074	8228-ZK-10374
10.7	8228-ZK-11075	8228-ZK-10075	8228-ZK-10375
10.8	8228-ZK-11076	8228-ZK-10076	8228-ZK-10376
10.9	8228-ZK-11077	8228-ZK-10077	8228-ZK-10377
11.0	8228-ZK-11078	8228-ZK-10078	8228-ZK-10378



Megrendelésre Volcera anyagból készült tájolócsapokat is szállítunk.
Termékkód: „8440-ZK-xxxxx” (az „xxxxx” a táblázatban lévő utolsó öt szám)

M8 CSAVARANYA HEGESZTŐ ÖSSZEÁLLÍTÁS VÍZHŰTÉSŰ

Pro
Spot

ELEKTRODATARTÓK

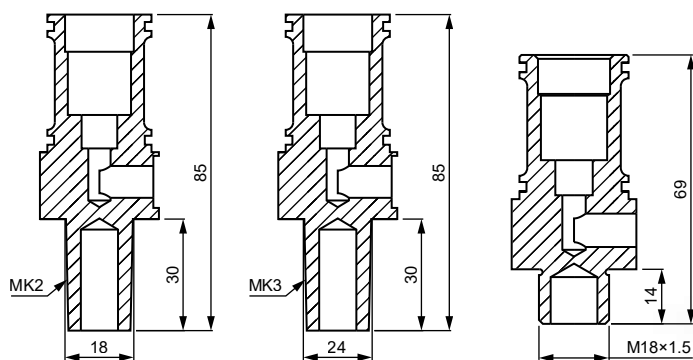

ANYA MÉRET	MK2 KÚP	MK3 KÚP	M18x1.5 MENET
M8	1111-ZK-20542	1111-ZK-20543	1111-ZK-20562

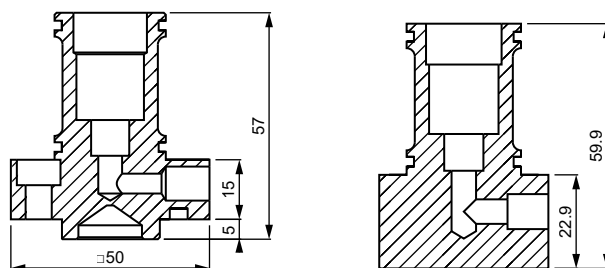

ANYA MÉRET	R-TÍPUS	C-TÍPUS
M8	1111-ZK-20642	1111-ZK-20662

HŰTŐ GYŰRŰ

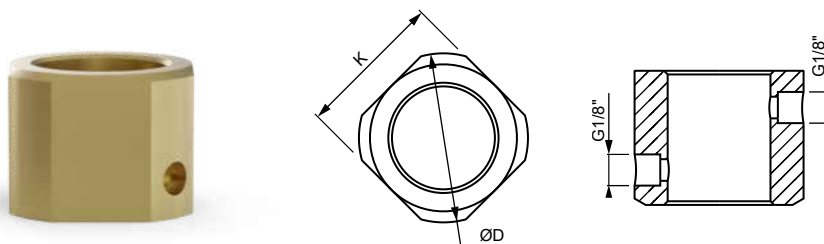

ANYA MÉRET	MEGJELÖLÉS	ØD	K
M4 – M8	1113-ZK-19766	46	40
C-típus M4 – M8	1113-ZK-19766	46	40

TARTOZÉKOK ELEKTRODATARTÓKHOZ

RUGÓ



TARTÓ HOSSZ	MEGJELÖLÉS
40 mm-tól	1112-ZK-12206

O-GYŰRŰ



TARTÓ TÍPUS	MEGJELÖLÉS
Ø28	1123-ZK-16436

GYORSCSATLAKOZÓ



—	MEGJELÖLÉS
sűrített levegő bevezető G1/8"-Ø6	1116-ZK-12353

DOCCERAM
ADVANCED CERAMIC SOLUTIONS

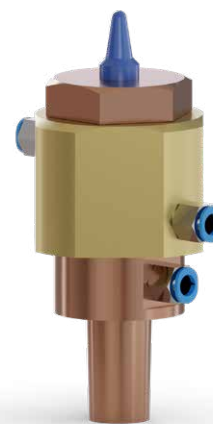

CSERÉLHETŐ
ELEKTRODA

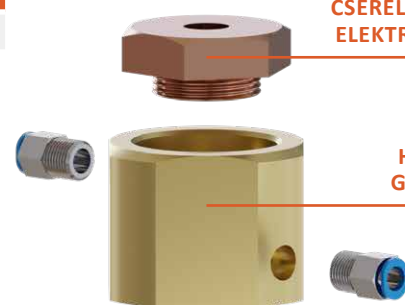

HŰTŐ
GYŰRŰ

TÁJOLÓCSAP



RUGÓ



ELEKTRODA
TARTÓ
O-GYŰRŰKKEL



GYORS-
CSATLAKOZÓ
SŰRÍTETT
LEVEGŐRE

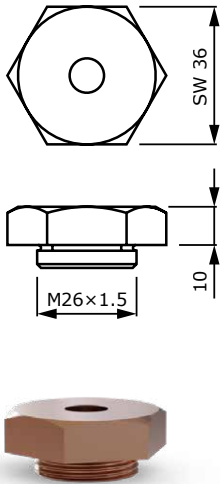

RÖVID

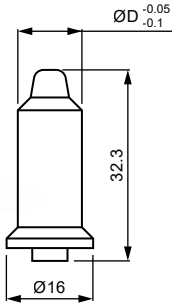

HOSSZÚ

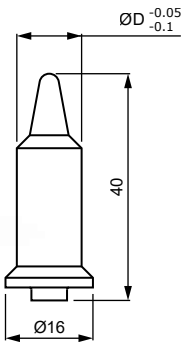

GALLÉROS

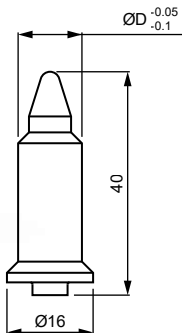

CSERÉLHETŐ ELEKTRODÁK

LEMEZ FURAT ØD	SW 36	LEMEZ FURAT ØD	SW 36
11.0	1111-ZK-20166	12.3	1111-ZK-20179
11.1	1111-ZK-20167	12.4	1111-ZK-20180
11.2	1111-ZK-20168	12.5	1111-ZK-20181
11.3	1111-ZK-20169	12.6	1111-ZK-20182
11.4	1111-ZK-20170	12.7	1111-ZK-20183
11.5	1111-ZK-20171	12.8	1111-ZK-20184
11.6	1111-ZK-20172	12.9	1111-ZK-20185
11.7	1111-ZK-20173	13.0	1111-ZK-20186
11.8	1111-ZK-20174	13.1	1111-ZK-20187
11.9	1111-ZK-20175	13.2	1111-ZK-20188
12.0	1111-ZK-20176	13.3	1111-ZK-20189
12.1	1111-ZK-20177	13.4	1111-ZK-20190
12.2	1111-ZK-20178	13.5	1111-ZK-20191

CERAZUR KERÁMIA TÁJOLÓCSAPOK

LEMEZ FURAT ØD	RÖVID	HOSSZÚ	GALLÉROS
11.0	8228-ZK-11079	8228-ZK-10079	8228-ZK-10379
11.1	8228-ZK-11080	8228-ZK-10080	8228-ZK-10380
11.2	8228-ZK-11081	8228-ZK-10081	8228-ZK-10381
11.3	8228-ZK-11082	8228-ZK-10082	8228-ZK-10382
11.4	8228-ZK-11083	8228-ZK-10083	8228-ZK-10383
11.5	8228-ZK-11084	8228-ZK-10084	8228-ZK-10384
11.6	8228-ZK-11085	8228-ZK-10085	8228-ZK-10385
11.7	8228-ZK-11086	8228-ZK-10086	8228-ZK-10386
11.8	8228-ZK-11087	8228-ZK-10087	8228-ZK-10387
11.9	8228-ZK-11088	8228-ZK-10088	8228-ZK-10388
12.0	8228-ZK-11089	8228-ZK-10089	8228-ZK-10389
12.1	8228-ZK-11090	8228-ZK-10090	8228-ZK-10390
12.2	8228-ZK-11091	8228-ZK-10091	8228-ZK-10391
12.3	8228-ZK-11092	8228-ZK-10092	8228-ZK-10392
12.4	8228-ZK-11093	8228-ZK-10093	8228-ZK-10393
12.5	8228-ZK-11094	8228-ZK-10094	8228-ZK-10394
12.6	8228-ZK-11095	8228-ZK-10095	8228-ZK-10395
12.7	8228-ZK-11096	8228-ZK-10096	8228-ZK-10396
12.8	8228-ZK-11097	8228-ZK-10097	8228-ZK-10397
12.9	8228-ZK-11098	8228-ZK-10098	8228-ZK-10398
13.0	8228-ZK-11099	8228-ZK-10099	8228-ZK-10399



Megrendelésre Volcera anyagból készült tájolócsapokat is szállítunk.
Termékkód: „8440-ZK-xxxxx” (az „xxxxx” a táblázatban szereplő
termékek utolsó öt számával azonos, pl. Ø11.0-nál a kód 8440-ZK-11079)

M10 CSAVARANYA HEGESZTŐ ÖSSZEÁLLÍTÁS

VÍZHŰTÉSŰ

Pro
Spot

ELEKTRODATARTÓK

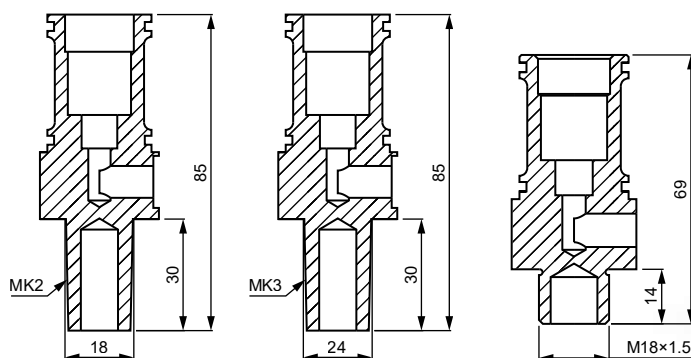

ANYA MÉRET	MK2 KÚP	MK3 KÚP	M18x1.5 MENET
M10	1111-ZK-20544	1111-ZK-20545	1111-ZK-20563

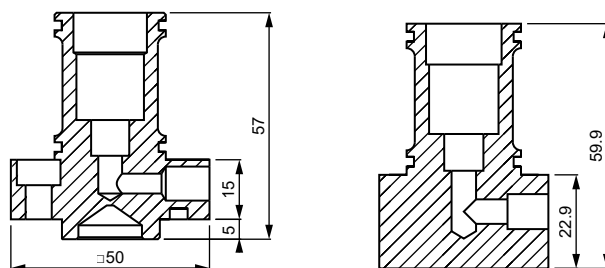

ANYA MÉRET	R-TÍPUS	C-TÍPUS
M10	1111-ZK-10644	1111-ZK-10663

HŰTŐ GYŰRŰ

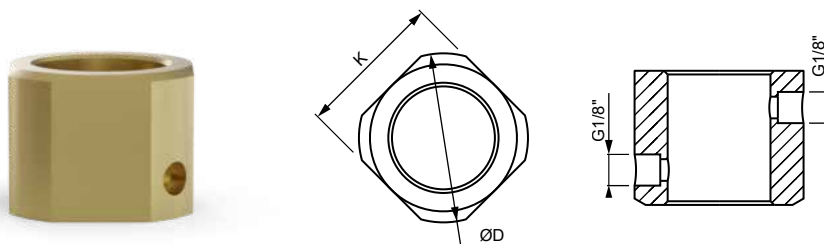

ANYA MÉRET	MEGJELÖLÉS	ØD	K
M10 – M12	1113-ZK-19767	52	46
C-típus M10 – M12	1113-ZK-19769	52	46

TARTOZÉKOK ELEKTRODATARTÓKHOZ

RUGÓ



TARTÓ HOSSZ	MEGJELÖLÉS
40 mm-től	1112-ZK-12207

O-GYŰRŰ



TYP DRŽIACA	MEGJELÖLÉS
Ø34	1123-ZK-26187

GYORSCSATLAKOZÓ



—	MEGJELÖLÉS
sűrített levegő bevezető G1/8"-Ø6	1116-ZK-12353

DOCCERAM
ADVANCED CERAMIC SOLUTIONS

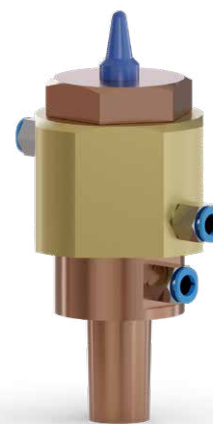

CSERÉLHETŐ
ELEKTRODA

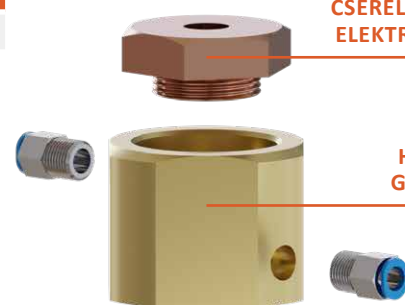

HŰTŐ
GYŰRŰ

TÁJOLÓCSAP



RUGÓ



ELEKTRODA
TARTÓ
O-GYŰRŰKKEL



GYORSCSATLAKOZÓ
SŰRÍTETT
LEVEGŐRE



DOCERAM
ADVANCED CERAMIC SOLUTIONS

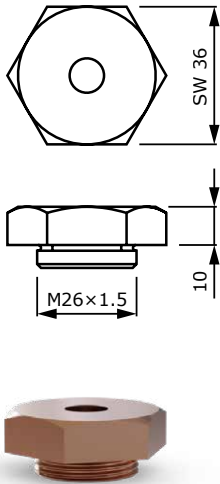

Cerazur



RÖVID

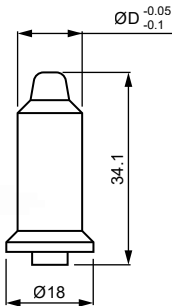

HOSSZÚ

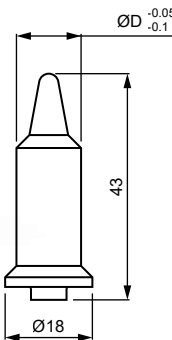

GALLÉROS

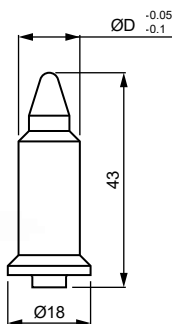

CSERÉLHETŐ ELEKTRODÁK

LEMEZ FURAT ØD	SW 36	LEMEZ FURAT ØD	SW 36
13.0	1111-ZK-20192	14.3	1111-ZK-20205
13.1	1111-ZK-20193	14.4	1111-ZK-20206
13.2	1111-ZK-20194	14.5	1111-ZK-20207
13.3	1111-ZK-20195	14.6	1111-ZK-20208
13.4	1111-ZK-20196	14.7	1111-ZK-20209
13.5	1111-ZK-20197	14.8	1111-ZK-20210
13.6	1111-ZK-20198	14.9	1111-ZK-20211
13.7	1111-ZK-20199	15.0	1111-ZK-20212
13.8	1111-ZK-20200	15.1	1111-ZK-20213
13.9	1111-ZK-20201	15.2	1111-ZK-20214
14.0	1111-ZK-20202	15.3	1111-ZK-20215
14.1	1111-ZK-20203	15.4	1111-ZK-20216
14.2	1111-ZK-20204	15.5	1111-ZK-20217

CERAZUR KERÁMIA TÁJOLÓCSAPOK

LEMEZ FURAT ØD	RÖVID	HOSSZÚ	GALLÉROS
13.0	8228-ZK-11100	8228-ZK-10100	8228-ZK-10400
13.1	8228-ZK-11101	8228-ZK-10101	8228-ZK-10401
13.2	8228-ZK-11102	8228-ZK-10102	8228-ZK-10402
13.3	8228-ZK-11103	8228-ZK-10103	8228-ZK-10403
13.4	8228-ZK-11104	8228-ZK-10104	8228-ZK-10404
13.5	8228-ZK-11105	8228-ZK-10105	8228-ZK-10405
13.6	8228-ZK-11106	8228-ZK-10106	8228-ZK-10406
13.7	8228-ZK-11107	8228-ZK-10107	8228-ZK-10407
13.8	8228-ZK-11108	8228-ZK-10108	8228-ZK-10408
13.9	8228-ZK-11109	8228-ZK-10109	8228-ZK-10409
14.0	8228-ZK-11110	8228-ZK-10110	8228-ZK-10410
14.1	8228-ZK-11111	8228-ZK-10111	8228-ZK-10411
14.2	8228-ZK-11112	8228-ZK-10112	8228-ZK-10412
14.3	8228-ZK-11113	8228-ZK-10113	8228-ZK-10413
14.4	8228-ZK-11114	8228-ZK-10114	8228-ZK-10414
14.5	8228-ZK-11115	8228-ZK-10115	8228-ZK-10415
14.6	8228-ZK-11116	8228-ZK-10116	8228-ZK-10416
14.7	8228-ZK-11117	8228-ZK-10117	8228-ZK-10417
14.8	8228-ZK-11118	8228-ZK-10118	8228-ZK-10418
14.9	8228-ZK-11119	8228-ZK-10119	8228-ZK-10419
15.0	8228-ZK-11120	8228-ZK-10120	8228-ZK-10420



Megrendelésre Volcera anyagból készült tájolócsapokat is szállítunk.
Termékkód: „8440-ZK-xxxxx” (az „xxxxx” a táblázatban szereplő
termékek utolsó öt számával azonos, pl. Ø13.0-nál a kód 8440-ZK-11100)

M12 CSAVARANYA HEGESZTŐ ÖSSZEÁLLÍTÁS VÍZHŰTÉSŰ

Pro
Spot

ELEKTRODATARTÓK

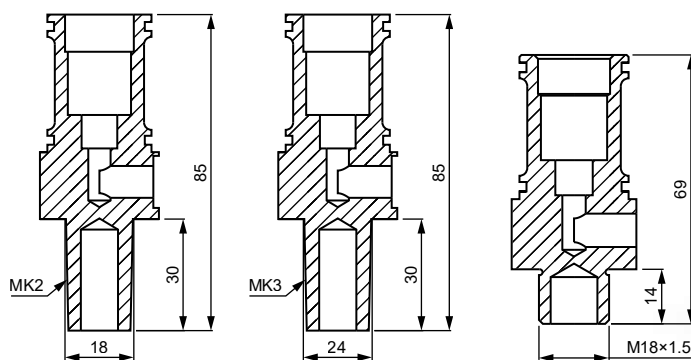

ANYA MÉRET	MK2 KÚP	MK3 KÚP	M18x1.5 MENET
M12	1111-ZK-20544	1111-ZK-20545	1111-ZK-20563

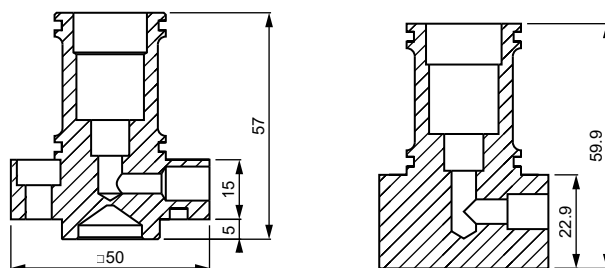

ANYA MÉRET	R-TÍPUS	C-TÍPUS
M12	1111-ZK-10644	1111-ZK-10663

HŰTŐ GYŰRŰ

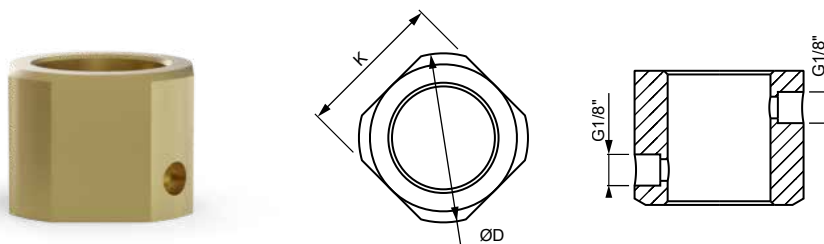

ANYA MÉRET	MEGJELÖLÉS	$\varnothing D$	K
M10 – M12	1113-ZK-19767	52	46
C-típus M10 – M12	1113-ZK-19769	52	46

TARTOZÉKOK ELEKTRODATARTÓKHOZ

RUGÓ



TARTÓ HOSSZ	MEGJELÖLÉS
40 mm-tól	1112-ZK-12207

O-GYŰRŰ



TARTÓ TÍPUS	MEGJELÖLÉS
$\varnothing 34$	1123-ZK-26187

GYORSCSATLAKOZÓ



—	MEGJELÖLÉS
sűrített levegő bevezető $G1/8"$ - $\varnothing 6$	1116-ZK-12353

ADVANCED CERAMIC SOLUTIONS
DOCERAM[®]

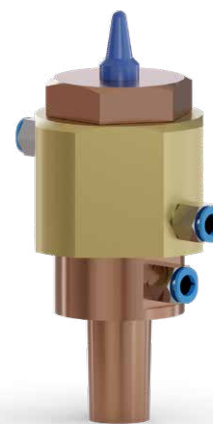

CSERÉLHETŐ
ELEKTRODA

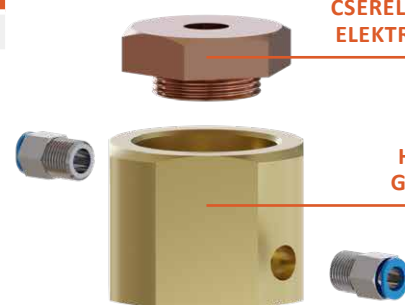

HŰTŐ
GYŰRŰ

TÁJOLÓCSAP



RUGÓ



ELEKTRODA
TARTÓ
O-GYŰRŰKKEL



GYORS-
CSATLAKOZÓ
SŰRÍTETT
LEVEGŐRE



DOCERAM
ADVANCED CERAMIC SOLUTIONS

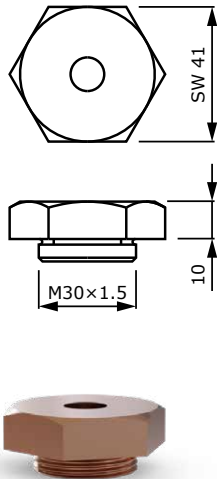

Cerazur



RÖVID

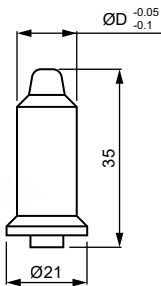

HOSSZÚ

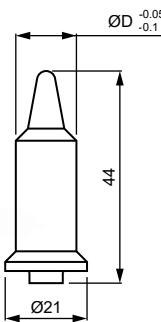

GALLÉROS

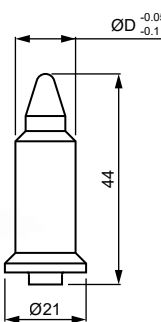

CSERÉLHETŐ ELEKTRODÁK

LEMEZ FURAT ØD	SW 41	LEMEZ FURAT ØD	SW 41
15.0	1111-ZK-10218	16.3	1111-ZK-10231
15.1	1111-ZK-10219	16.4	1111-ZK-10232
15.2	1111-ZK-10220	16.5	1111-ZK-10233
15.3	1111-ZK-10221	16.6	1111-ZK-10234
15.4	1111-ZK-10222	16.7	1111-ZK-10235
15.5	1111-ZK-10223	16.8	1111-ZK-10236
15.6	1111-ZK-10224	16.9	1111-ZK-10237
15.7	1111-ZK-10225	17.0	1111-ZK-10238
15.8	1111-ZK-10226	17.1	1111-ZK-10239
15.9	1111-ZK-10227	17.2	1111-ZK-10240
16.0	1111-ZK-10228	17.3	1111-ZK-10241
16.1	1111-ZK-10229	17.4	1111-ZK-10242
16.2	1111-ZK-10230	17.5	1111-ZK-10243

CERAZUR KERÁMIA TÁJOLÓCSAPOK

LEMEZ FURAT ØD	RÖVID	HOSSZÚ	GALLÉROS
15.0	8228-ZK-11121	8228-ZK-10121	8228-ZK-10421
15.1	8228-ZK-11122	8228-ZK-10122	8228-ZK-10422
15.2	8228-ZK-11123	8228-ZK-10123	8228-ZK-10423
15.3	8228-ZK-11124	8228-ZK-10124	8228-ZK-10424
15.4	8228-ZK-11125	8228-ZK-10125	8228-ZK-10425
15.5	8228-ZK-11126	8228-ZK-10126	8228-ZK-10426
15.6	8228-ZK-11127	8228-ZK-10127	8228-ZK-10427
15.7	8228-ZK-11128	8228-ZK-10128	8228-ZK-10428
15.8	8228-ZK-11129	8228-ZK-10129	8228-ZK-10429
15.9	8228-ZK-11130	8228-ZK-10130	8228-ZK-10430
16.0	8228-ZK-11131	8228-ZK-10131	8228-ZK-10431
16.1	8228-ZK-11132	8228-ZK-10132	8228-ZK-10432
16.2	8228-ZK-11133	8228-ZK-10133	8228-ZK-10433
16.3	8228-ZK-11134	8228-ZK-10134	8228-ZK-10434
16.4	8228-ZK-11135	8228-ZK-10135	8228-ZK-10435
16.5	8228-ZK-11136	8228-ZK-10136	8228-ZK-10436
16.6	8228-ZK-11137	8228-ZK-10137	8228-ZK-10437
16.7	8228-ZK-11138	8228-ZK-10138	8228-ZK-10438
16.8	8228-ZK-11139	8228-ZK-10139	8228-ZK-10439
16.9	8228-ZK-11140	8228-ZK-10140	8228-ZK-10440
17.0	8228-ZK-11141	8228-ZK-10141	8228-ZK-10441
17.1	8228-ZK-11142	8228-ZK-10142	8228-ZK-10442
17.2	8228-ZK-11143	8228-ZK-10143	8228-ZK-10443
17.3	8228-ZK-11144	8228-ZK-10144	8228-ZK-10444
17.4	8228-ZK-11145	8228-ZK-10145	8228-ZK-10445
17.5	8228-ZK-11146	8228-ZK-10146	8228-ZK-10446



Megrendelésre Volcera anyagból készült tájolócsapokat is szállítunk.
Termékkód: „8440-ZK-xxxx” (az „xxxx” a táblázatban szereplő
termékek utolsó öt számával azonos, pl. Ø13.0-nál a kód 8440-ZK-11121)

M14 CSAVARANYA HEGESZTŐ ÖSSZEÁLLÍTÁS VÍZHŰTÉSŰ

Pro
Spot

ELEKTRÓDATARTÓK

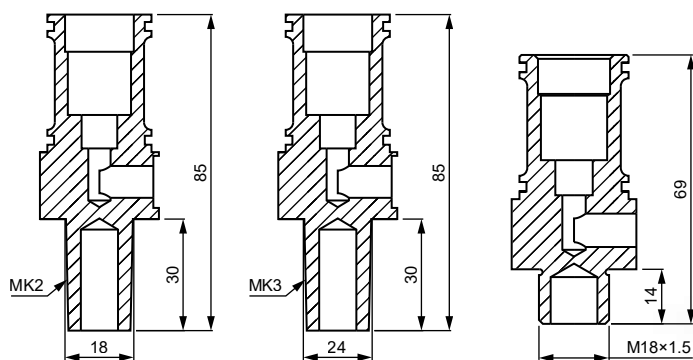

ANYA MÉRET	MK2 KÚP	MK3 KÚP	M18x1.5 MENET
M14	1111-ZK-20565	1111-ZK-20566	1111-ZK-20567

HŰTŐ GYŰRŰ

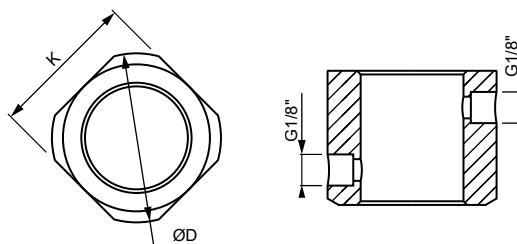

ANYA MÉRET	MEGJELÖLÉS	ØD	K
M14	1113-ZK-19770	65	56

TARTOZÉKOK ELEKTRÓDATARTÓKHOZ

RUGÓ



TARTÓ HOSSZ	MEGJELÖLÉS
40 mm-től	1112-ZK-12207

O-GYŰRŰ



TARTÓ TÍPUS	MEGJELÖLÉS
M14	1123-Z-77089

GYORSCSATLAKOZÓ



—	MEGJELÖLÉS
sűrített levegő bevezető G1/8"-Ø6	1116-ZK-12353

ADVANCED CERAMIC SOLUTIONS
DOCERAM[®]

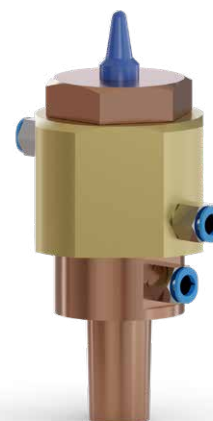

CSERÉLHETŐ
ELEKTRÓDA

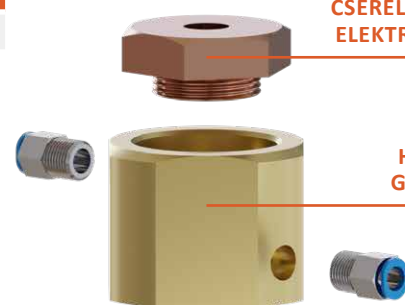

HŰTŐ
GYŰRŰ

TÁJOLÓCSAP



RUGÓ



ELEKTRÓDA
TARTÓ
O-GYŰRŰKKEL



GYORSCSATLAKOZÓ
SŰRÍTETT
LEVEGŐRE



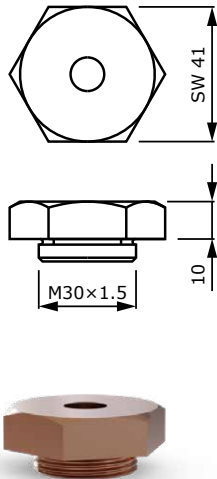

RÖVID

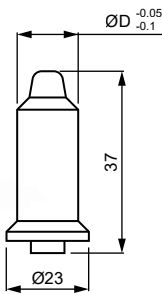

HOSSZÚ

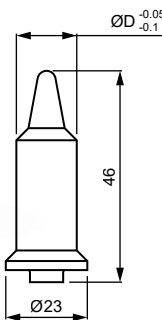

GALLÉROS

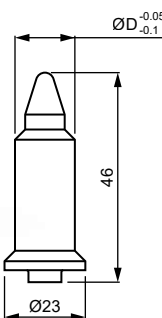

CSERÉLHETŐ ELEKTRODÁK

LEMEZ FURAT ØD	SW 41	LEMEZ FURAT ØD	SW 41
17.0	1111-ZK-10244	18.3	1111-ZK-10257
17.1	1111-ZK-10245	18.4	1111-ZK-10258
17.2	1111-ZK-10246	18.5	1111-ZK-10259
17.3	1111-ZK-10247	18.6	1111-ZK-10260
17.4	1111-ZK-10248	18.7	1111-ZK-10261
17.5	1111-ZK-10249	18.8	1111-ZK-10262
17.6	1111-ZK-10250	18.9	1111-ZK-10263
17.7	1111-ZK-10251	19.0	1111-ZK-10264
17.8	1111-ZK-10252	19.1	1111-ZK-10265
17.9	1111-ZK-10253	19.2	1111-ZK-10266
18.0	1111-ZK-10254	19.3	1111-ZK-10267
18.1	1111-ZK-10255	19.4	1111-ZK-10268
18.2	1111-ZK-10256	19.5	1111-ZK-10269

CERAZUR KERÁMIA TÁJOLÓCSAPOK

LEMEZ FURAT ØD	RÖVID	HOSSZÚ	GALLÉROS
17.0	8228-ZK-11147	8228-ZK-10147	8228-ZK-10447
17.1	8228-ZK-11148	8228-ZK-10148	8228-ZK-10448
17.2	8228-ZK-11149	8228-ZK-10149	8228-ZK-10449
17.3	8228-ZK-11150	8228-ZK-10150	8228-ZK-10450
17.4	8228-ZK-11151	8228-ZK-10151	8228-ZK-10451
17.5	8228-ZK-11152	8228-ZK-10152	8228-ZK-10452
17.6	8228-ZK-11153	8228-ZK-10153	8228-ZK-10453
17.7	8228-ZK-11154	8228-ZK-10154	8228-ZK-10454
17.8	8228-ZK-11155	8228-ZK-10155	8228-ZK-10455
17.9	8228-ZK-11156	8228-ZK-10156	8228-ZK-10456
18.0	8228-ZK-11157	8228-ZK-10157	8228-ZK-10457
18.1	8228-ZK-11158	8228-ZK-10158	8228-ZK-10458
18.2	8228-ZK-11159	8228-ZK-10159	8228-ZK-10459
18.3	8228-ZK-11160	8228-ZK-10160	8228-ZK-10460
18.4	8228-ZK-11161	8228-ZK-10161	8228-ZK-10461
18.5	8228-ZK-11162	8228-ZK-10162	8228-ZK-10462
18.6	8228-ZK-11163	8228-ZK-10163	8228-ZK-10463
18.7	8228-ZK-11164	8228-ZK-10164	8228-ZK-10464
18.8	8228-ZK-11165	8228-ZK-10165	8228-ZK-10465
18.9	8228-ZK-11166	8228-ZK-10166	8228-ZK-10466
19.0	8228-ZK-11167	8228-ZK-10167	8228-ZK-10467
19.1	8228-ZK-11168	8228-ZK-10168	8228-ZK-10468
19.2	8228-ZK-11169	8228-ZK-10169	8228-ZK-10469
19.3	8228-ZK-11170	8228-ZK-10170	8228-ZK-10470
19.4	8228-ZK-11171	8228-ZK-10171	8228-ZK-10471
19.5	8228-ZK-11172	8228-ZK-10172	8228-ZK-10472



Megrendelésre Volcera anyagból készült tájolócsapokat is szállítunk.
Termékkód: „8440-ZK-xxxx” (az „xxxx” a táblázatban szereplő
termékek utolsó öt számával azonos, pl. Ø13.0-nál a kód 8440-ZK-11147)

M16 CSAVARANYA HEGESZTŐ ÖSSZEÁLLÍTÁS VÍZHŰTÉSŰ

Pro
Spot

ELEKTRODATARTÓK

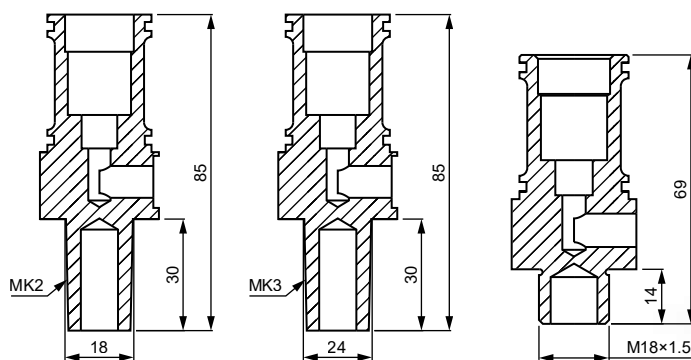

ANYA MÉRET	MK2 KÚP	MK3 KÚP	M18x1.5 MENET
M16	1111-ZK-20565	1111-ZK-20566	1111-ZK-20567

HŰTŐ GYŰRŰ

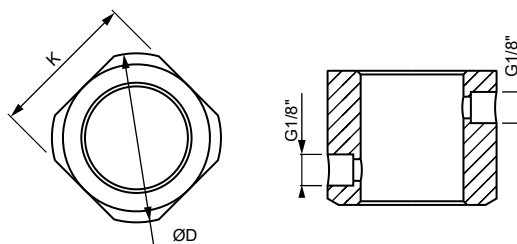

ANYA MÉRET	MEGJELÖLÉS	ØD	K
M16	1113-ZK-19770	65	56

TARTOZÉKOK ELEKTRODATARTÓKHOZ

RUGÓ



TARTÓ HOSSZ	MEGJELÖLÉS
40 mm-től	1112-ZK-12207

O-GYŰRŰ



TARTÓ TÍPUS	MEGJELÖLÉS
M16	1123-Z-77089

GYORSCSATLAKOZÓ



—	MEGJELÖLÉS
sűrített levegő bevezető G1/8"-Ø6	1116-ZK-12353

ADVANCED CERAMIC SOLUTIONS
DOCERAM[®]

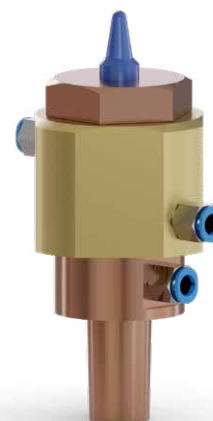

CSERÉLHETŐ
ELEKTRODA

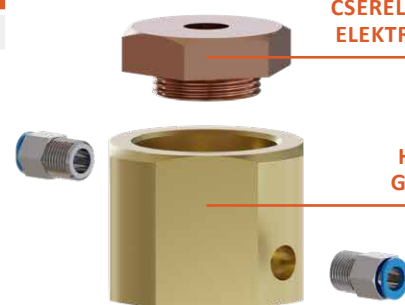

HŰTŐ
GYŰRŰ

TÁJOLÓCSAP



RUGÓ



ELEKTRODA
TARTÓ
O-GYŰRŰKKEL



GYORSCSATLAKOZÓ
SŰRÍTETT
LEVEGŐRE

