

CSERÉLHETŐ
ELEKTÓDA

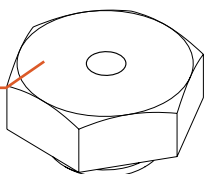

BEILLESZTETT
PERSELY



TÁVTARTÓ

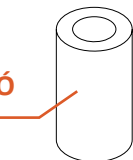

ELEKTÓDA
TARTÓ

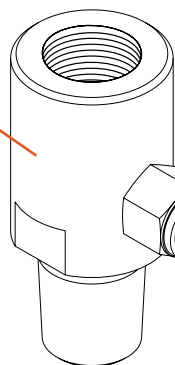

GYORSCSATLAKOZÓ
SŰRÍTETT
LEVEGŐRE



TARTOZÉKOK

TÁVTARTÓ

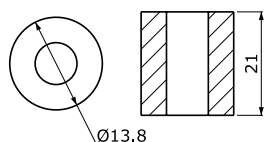

CSAVAR MÉRET	MEGJELÖLÉS
M4	1115-ZK-12000
M5	1115-ZK-12001
M6	1115-ZK-12002

O-GYŰRŰ

TARTÓ MÉRET	MEGJELÖLÉS
Ø24	1123-ZK-16435
Ø28	1123-ZK-16436
PERSELY	MEGJELÖLÉS
csavar méret M4 – M6	1123-ZK-16437

GYORSCSATLAKOZÓ

—	MEGJELÖLÉS
sűrített levegő bevezető G1/8"-Ø6	1116-ZK-12353

KERÁMIA PERSELY

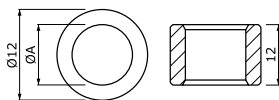

CSERÉLHETŐ ELEKTÓDÁK

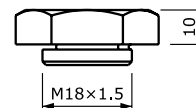
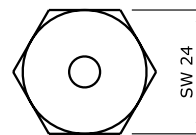

CSAVAR MÉRET	MEGJELÖLÉS	ØA	CSAVAR MÉRET	SW 24
M4	8440-ZK-13000	4	M4	1111-ZK-13000
M5	8440-ZK-13001	5	M5	1111-ZK-13001
M6	8440-ZK-13002	6	M6	1111-ZK-13002

ELEKTÓDATARTÓK

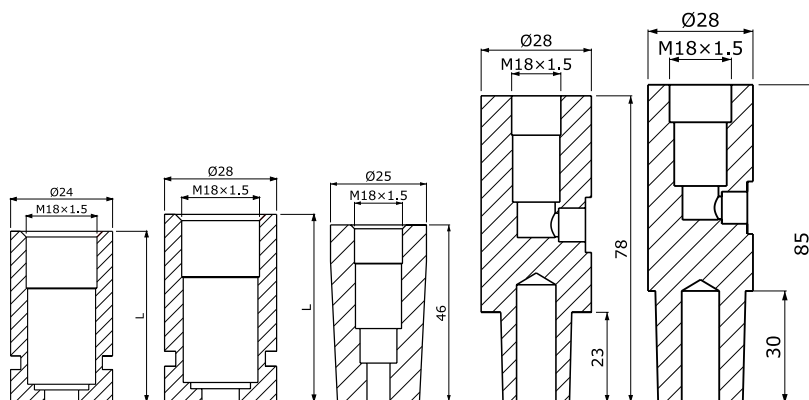

L	Ø24	Ø28	1:10 KÚP	MK2 KÚP	MK3 KÚP
40	1111-ZK-10512	1111-ZK-10515	—	—	—
50	1111-ZK-10513	1111-ZK-10516	—	—	—
60	1111-ZK-10514	1111-ZK-10517	—	—	—
—	—	—	1111-ZK-10582	1111-ZK-10542	1111-ZK-10543

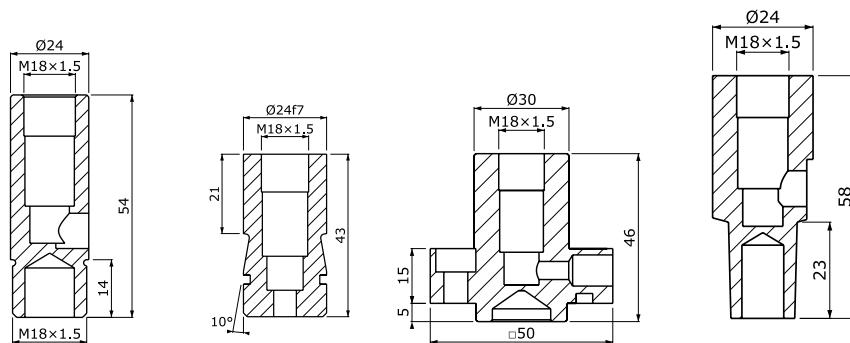

—	MEGJELÖLÉS	M18x1.5 MENET	S-TÍPUS	R-TÍPUS	T-TÍPUS
—	—	1111-ZK-10562	1111-ZK-10682	1111-ZK-10616	1111-ZK-10642

M8 – M12 CSAVAR HEGESZTŐ ÖSSZEÁLLÍTÁS LÉGHŰTÉSŰ



CSERÉLHETŐ ELEKTÓDÁK

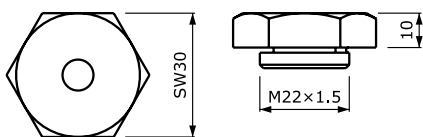

KERÁMIA PERSELY

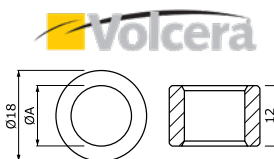

CSAVAR MÉRET	SW 30	CSAVAR MÉRET	MEGJELÖLÉS	ØA
M8	1111-ZK-13003	M8	8440-ZK-13003	8
M10	1111-ZK-13004	M10	8440-ZK-13004	10
M12	1111-ZK-13005	M12	8440-ZK-13005	12

ELEKTÓDATARTÓK

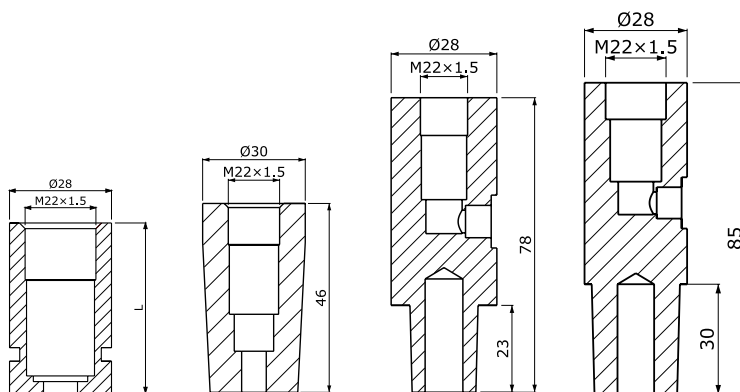

L	Ø28	1:10 KÚP	MK2 KÚP	MK3 KÚP
40	1111-ZK-10521	—	—	—
50	1111-ZK-10522	—	—	—
60	1111-ZK-10523	—	—	—
—	—	1111-ZK-10584	1111-ZK-10546	1111-ZK-10547

ELEKTÓDA TARTÓ

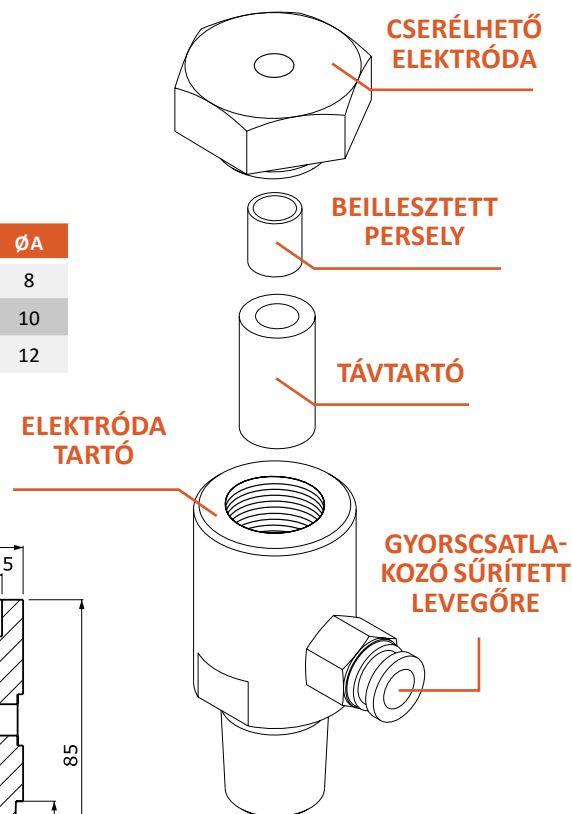

TARTOZÉKOK

TÁVTARTÓ

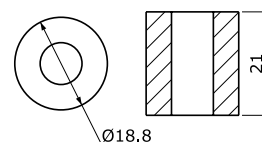

CSAVAR MÉRET	MEGJELÖLÉS
M8	1115-ZK-12003
M10	1115-ZK-12004
M12	1115-ZK-12005

O-GYŰRŰ

TARTÓ MÉRET	MEGJELÖLÉS
Ø24	1123-ZK-16435
Ø28	1123-ZK-16436

PERSELY	MEGJELÖLÉS
csavar méret M8 – M12	1123-ZK-16438

GYORSCSATLAKOZÓ

—	MEGJELÖLÉS
sűrített levegő bevezető G1/8"-Ø6	1116-ZK-12353

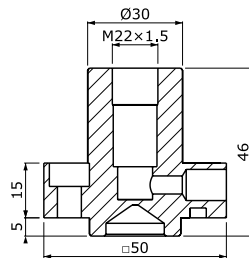
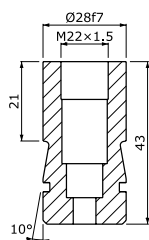
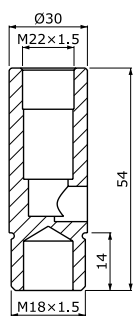

M18x1.5 MENET	S-TÍPUS	R-TÍPUS
1111-ZK-10564	1111-ZK-10684	1111-ZK-10622

DOGLAS
180 G

CSERÉLHETŐ
ELEKTÓDA



HŰTŐ
GYŰRŰ

BEILLESZTETT
PERSELY

O-GYŰRŰ

TÁVTARTÓ

O-GYŰRŰ

ELEKTÓDA
TARTÓ

GYORSCSATLA-
KOZÓ SŰRÍTETT
LEVEGŐRE

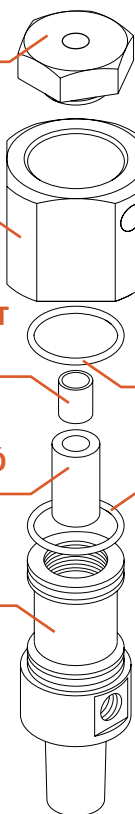

KERÁMIA PERSELY

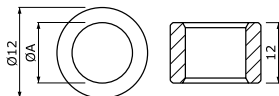

CSERÉLHETŐ ELEKTÓDÁK

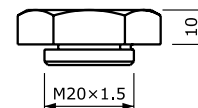
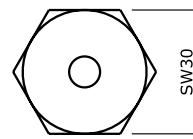

CSAVAR MÉRET	MEGJELÖLÉS	ØA	CSAVAR MÉRET	SW 30
M4	8440-ZK-13000	4	M4	1111-ZK-22000
M5	8440-ZK-13001	5	M5	1111-ZK-22001
M6	8440-ZK-13002	6	M6	1111-ZK-22002

ELEKTÓDATARTÓK

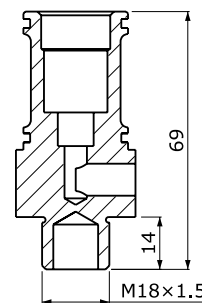
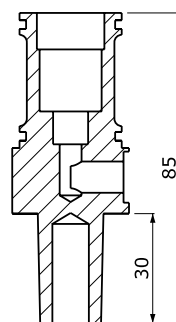
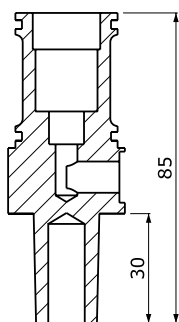

MK2 KÚP	MK3 KÚP	M18x1.5 MENET
1111-ZK-20542	1111-ZK-20543	1111-ZK-20562

TARTOZÉKOK

TÁVTARTÓ

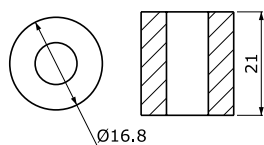

CSAVAR MÉRET	MEGJELÖLÉS
M4	1115-ZK-13000
M5	1115-ZK-13001
M6	1115-ZK-13002

O-GYŰRŰ

TARTÓ MÉRET	MEGJELÖLÉS
Ø28	1123-ZK-16436
Ø34	1123-ZK-26187
PERSELY	MEGJELÖLÉS
csavar méret M4 – M6	1123-ZK-16437

GYORSCSATLAKOZÓ

—	MEGJELÖLÉS
sűrített levegő bevezető G1/8"-Ø6	1116-ZK-12353

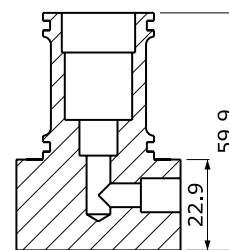
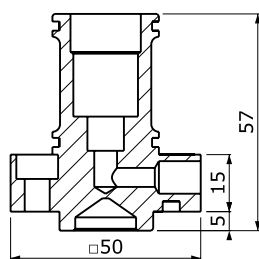

R-TÍPUS	C-TÍPUS
1111-ZK-20642	1111-ZK-20662

HŰTŐ GYŰRŰ

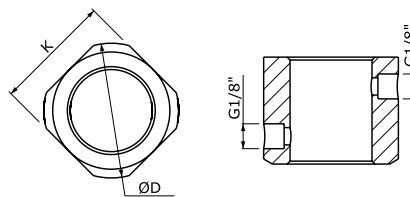

CSAVAR MÉRET	MEGJELÖLÉS	ØD	K
M4 – M6	1113-ZK-19766	46	40
C-típus M4 – M6	1113-ZK-19766	46	40

M8 – M12 CSAVAR HEGESZTŐ ÖSSZEÁLLÍTÁS VÍZHŰTÉSŰ



CSERÉLHETŐ ELEKTÓDÁK

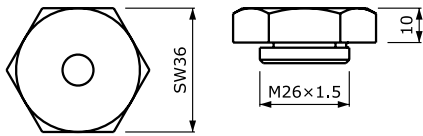

KERÁMIA PERSELY

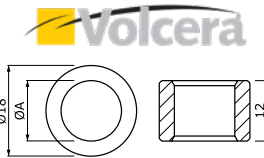

CSAVAR MÉRET	SW 36	CSAVAR MÉRET	MEGJELÖLÉS	ØA
M8	1111-ZK-22003	M8	8440-ZK-13003	8
M10	1111-ZK-22004	M10	8440-ZK-13004	10
M12	1111-ZK-22005	M12	8440-ZK-13005	12

ELEKTÓDATARTÓK

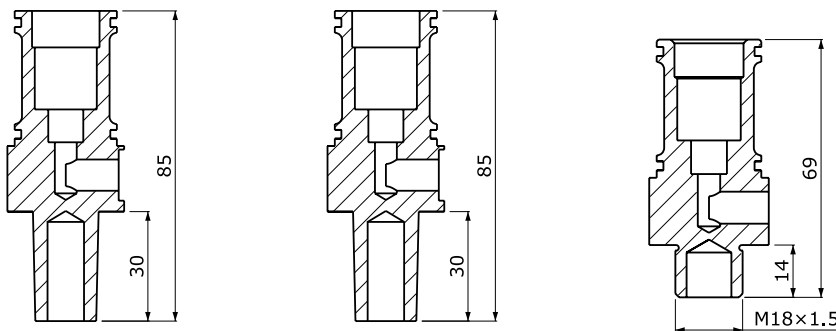

MK2 KÚP	MK3 KÚP	M18x1.5 MENET
1111-ZK-20544	1111-ZK-20545	1111-ZK-20563

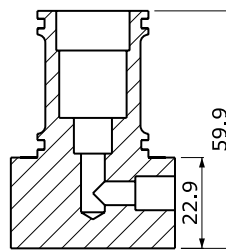
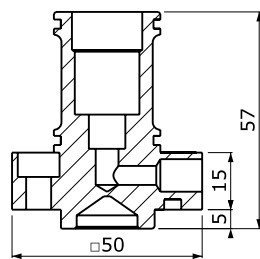

R-TÍPUS	C-TÍPUS
1111-ZK-20644	1111-ZK-20663

HŰTŐ GYŰRŰ

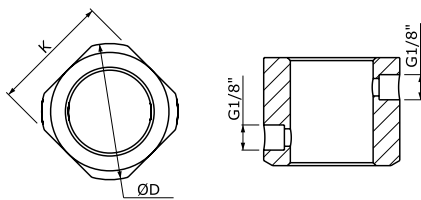

CSAVAR MÉRET	MEGJELÖLÉS	ØD	K
M8 – M12	1113-ZK-19767	52	46
C-típus M8 – M12	1113-ZK-19769	52	46

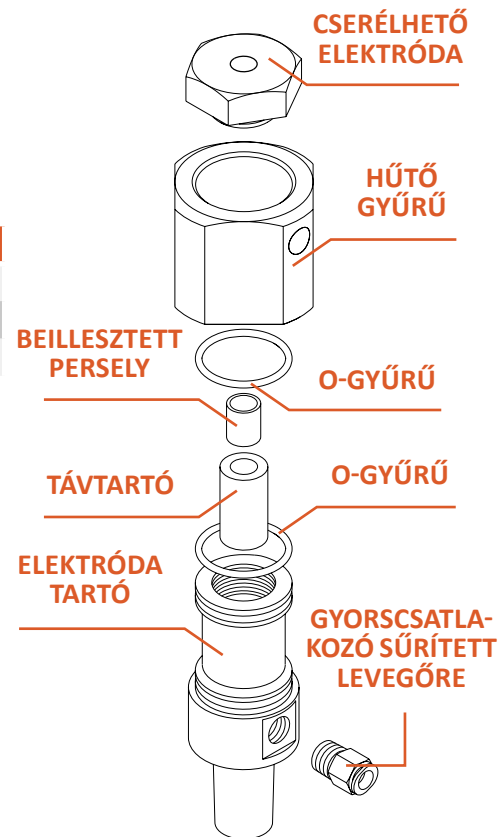

TARTOZÉKOK

TÁVTARTÓ

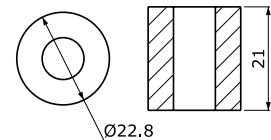

CSAVAR MÉRET	MEGJELÖLÉS
M8	1115-ZK-13003
M10	1115-ZK-13004
M12	1115-ZK-13005

O-GYŰRŰ

TARTÓ MÉRET	MEGJELÖLÉS
Ø28	1123-ZK-16436
Ø34	1123-ZK-26187

PERSELY	MEGJELÖLÉS
csavar méret M8 – M12	1123-ZK-16438

GYORSCSATLAKOZÓ

—	MEGJELÖLÉS
sűrített levegő bevezető G1/8"-Ø6	1116-ZK-12353

